

CHAPTER 5

Radionuclides in Nature

Contents

5.1.	Cosmogenic radionuclides	95
	5.1.1. Survey	95
	5.1.2. Tritium	96
	5.1.3. ¹⁴ C	97
5.2.	Primordial radionuclides	97
	5.2.1. Very long-lived nuclides lighter than lead	97
	5.2.2. Elements in the natural radioactive decay series	98
5.3.	Transuranic elements in nature and the Np decay series	99
5.4.	Thorium	103
	5.4.1. Isotopes	103
	5.4.2. Occurrence and production	103
	5.4.3. Uses	104
5.5.	Uranium	104
	5.5.1. Isotopes	104
	5.5.2. Occurrence, resources and production capacity	104
	5.5.3. Production techniques	105
	5.5.4. Production wastes	107
5.6.	Radium and radon in the environment	108
5.7.	Disequilibrium	109
5.8.	Age determination from radioactive decay	110
	5.8.1. Dating by ¹⁴ C method	111
	5.8.2. Dating by K-Ar method	112
	5.8.3. Dating by Rb-Sr method	114
	5.8.4. Dating based on ²³⁸ U decay	115
5.9.	Natural radioactivity of the oceans	116
5.10.	Anthropogenic radioactivity in nature	117
	5.10.1. Nuclear weapons	118
	5.10.2. Nuclear power plant accidents	119
	5.10.3. Releases from nuclear plants	120
	5.10.4. Other anthropogenic additions	120
5.11.	Exercises	121
5.12.	Literature	121

Practically all natural materials contain radioactive nuclides, though usually in such low concentrations that they can be detected only by very sensitive analysis. This is true for water (rain water, rivers, lakes, sea), rocks and soil, and all living matter, as well as for

TABLE 5.1.a. Long-lived cosmogenic radionuclides appearing in meteorites and rain water

Nuclide	Half-life (years)	Decay Mode & particle energy (MeV)	Atmospheric production rate (atoms m ⁻² s ⁻¹)
³ H	12.32	β^- 0.0186	2500
¹⁰ Be	1.52×10^6	β^- 0.555	300
¹⁴ C	5715	β^- 0.1565	17 000–25 000
²² Na	2.605	β^+ 0.545	0.5
²⁶ Al	7.1×10^5	β^+ 1.16	1.2
³² Si	160	β^- 0.213	1.6
³⁵ S	0.239 (87.2 d)	β^- 0.167	14
³⁶ Cl	3.01×10^5	β^- 0.709	60
³⁹ Ar	268	β^- 0.565	56
⁵³ Mn	3.7×10^6	EC (0.596)	
⁸¹ Kr	2.2×10^5	EC (0.28)	

Values within parenthesis after EC are decay energies.

structures based on natural raw materials except where great care has resulted in use of a non-radioactive material. The radionuclides in our environment can be divided into (i) those formed from cosmic radiation, (ii) those with lifetimes comparable to the age of the earth, (iii) those that are part of the natural decay chains beginning with thorium and uranium, and (iv) those introduced in nature by modern techniques. Sources can be categorized as: (i) *cosmogenic*, (ii) and (iii) *primordial*, and (iv) *anthropogenic*.

5.1. Cosmogenic radionuclides

5.1.1. Survey

Cosmic irradiation of the atmosphere produces neutrons and protons (Ch. 10) which react with N₂, O₂, Ar, etc. resulting in the production of radioactive nuclides, some of which are listed in Table 5.1 a and b. These nuclides are produced at constant rates and brought

TABLE 5.1.b. Short-lived cosmogenic radionuclides appearing in rain water

Nuclide	Half-life	Decay mode and particle energy (MeV)
⁷ Be	53.28 d	EC (0.862)
²⁴ Na	14.96 h	β^- 1.389
²⁸ Mg	21.0 h	β^- 0.459
³² P	14.28 d	β^- 1.710
³³ P	25.3 d	β^- 0.249
³⁹ Cl	55.6 min	β^- 1.91

Value within parenthesis is decay energy

Production rates (atoms m⁻² s⁻¹): ⁷Be 81, ³⁹Cl 16

to the earth surface by rain water. Though they are formed in extremely low concentrations, the global inventory is by no means small (§§5.1.2 and 5.1.3). Equilibrium is assumed to be established between the production rate and the mean residence time of these radionuclides in terrestrial reservoirs (the atmosphere, the sea, lakes, soil, plants, etc) leading to constant specific radioactivities of the elements in each reservoir. If a reservoir is closed from the environment, its specific radioactivity decreases. This can be used to determine exposure times of meteorites to cosmic radiation (and the constancy of the cosmic radiation field, using ^{81}Kr), dating marine sediments (using ^{10}Be , ^{26}Al), groundwater (^{36}Cl), glacial ice (^{10}Be), dead biological materials (^{14}C), etc. The shorter-lived cosmogenic radionuclides have been used as natural tracers for atmospheric mixing and precipitation processes (e.g. ^{39}Cl or ^{38}S). Only T and ^{14}C are of sufficient importance to deserve further discussion.

5.1.2. Tritium

Satellite measurements have shown that the earth receives some of the tritium ejected from the sun. Much larger amounts are formed in the atmosphere through nuclear reactions; e.g., between fast neutrons and nitrogen atoms

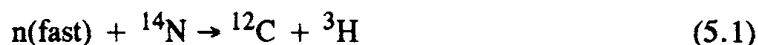

The yield for this reaction is about 2500 atoms tritium per second per square meter of the earth's surface; the global inventory is therefore about 1.3×10^{18} Bq. Tritium has a half-life of 12.33 y, decaying by weak β^- emission to ^3He . It is rapidly incorporated in water, entering the global hydrological cycle. The average residence time in the atmosphere is about 2 y which is a small fraction of the half-life, as once the tritiated water reaches the lower troposphere, it rains out in 5 - 20 days. If we define 1 TU (Tritium Unit) as 1 tritium atom per 10^{18} hydrogen atoms, 1 TU corresponds to 118 Bq/m³. Before the advent of nuclear energy, surface waters contained 2 - 8 TU (an average value of 3.5 TU is commonly used). The tritium content in water now commonly is of the order 20 - 40 TU. Rainwater contains between 4 and 25 TU, lower at the equatorial zone and increasing with latitude.

Tritium is also a product in the nuclear energy cycle, some of which is released to the atmosphere and some to the hydro sphere. The emissions differ between reactor types (usually in the order HWR > PWR > BWR, see Ch. 19) and is a function of the energy production. Assuming the annual releases to be 40 TBq/GW_e (Giga Watt electricity) from an average power plant and 600 TBq/GW_e from a typical reprocessing plant, the annual global injection of tritium in the environment is estimated to ~ 10 PBq in 1992. Though this is a small fraction of the natural production, it causes local increases.

The hydrogen bomb tests conducted in the atmosphere during the decade of the 1950's and early 1960's injected large amounts of tritium into the geosphere; 2.6×10^{20} Bq up to the end of the tests in 1962. This considerably exceeds the natural production inventory.

Before 1952 (first hydrogen bomb tests) the tritium content could be used to date water (i.e. determine when it became isolated from contact with the atmosphere). This was very

useful e.g. for determining ice ages. However, due to the much larger content of anthropogenic tritium presently, this is no longer a useful technique for such dating.

Tritium in concentrations as low as 1 TU can be measured in low background proportional counters, and, after isotope enrichment (e.g. by electrolysis of alkaline water, by which tritium is enriched in the remainder), down to 0.01 TU. For very low concentrations mass spectrometry is preferred.

5.1.3. ^{14}C -Carbon

^{14}C is produced in the atmosphere by a variety of reactions, the most important being between thermalized neutrons from cosmic radiation and nitrogen atoms:



This reaction occurs with a yield of approximately 22 000 atoms ^{14}C formed per s and m^2 of the earth's surface; the global annual production rate is ~ 1 PBq, and global inventory $\sim 8\,500$ PBq (corresponding to ~ 75 tons). Of this amount ~ 140 PBq remain in the atmosphere while the rest is incorporated in terrestrial material. All living material (incl. body tissue) has a ^{14}C concentration of ~ 227 Bq/kg. The half-life of ^{14}C is 5715 y; it decays by soft β^- emission ($E_{\text{max}} 158$ keV).

^{14}C is also formed by reaction (5.2) in nuclear tests. From these 220 PBq is assumed to have been injected into the atmosphere up to 1990. This ^{14}C comes to equilibrium with other atmospheric carbon (CO_2) in 1 – 2 years. Some ^{14}C , about 18 TBq/ GW_e per year, is also released from nuclear power plants (mainly from HWR, Ch. 19 and 22). The global atmospheric value is < 300 TBq/y.

The combustion of fossil fuel adds CO_2 , which is almost free of ^{14}C , to the atmosphere, thus reducing the specific activity (the dilution was about 3% for the period 1900 - 1970). Taking all anthropogenic sources into account, a global average specific activity of modern carbon is now 13.56 ± 0.07 dpm/g C. In §5.8.1 we discuss dating by the "C14-method", for which such a figure is important.

5.2. Primordial radionuclides

5.2.1. Very long-lived nuclides lighter than lead

As the detection technique for radioactivity has been refined, a number of long-lived radionuclides have been discovered in nature. The lightest have been mentioned in §5.1. The heavier ones, not belonging to the natural radioactive decay series of uranium and thorium, are listed in Table 5.2. ^{50}V is the nuclide of lowest elemental specific activity (~ 0.0001 Bq/g) while the highest are ^{87}Rb and ^{187}Re (each ~ 900 Bq/g). As our ability to make reliable measurements of low activities increases, the number of elements between potassium and lead with radioactive isotopes in nature can be expected to increase.

TABLE 5.2. Primordial radionuclides for $Z < 82$ (Pb)

Nuclide	Isotopic abundance %	Decay mode and particle energy MeV	Half-life (years)
^{40}K	0.0117	β^- EC 1.31	1.26×10^9
^{50}V	0.250	β^- EC (0.601)	$> 1.4 \times 10^{17}$
^{87}Rb	27.83	β^- 0.273	4.88×10^{10}
^{115}In	95.72	β^- 1.0	4.4×10^{14}
^{123}Te	0.905	EC (0.052)	1.3×10^{13}
^{138}La	0.092	β^- EC	1.06×10^{11}
^{144}Nd	23.80	α	2.1×10^{15}
^{147}Sm	15.0	α 2.23	1.06×10^{11}
^{148}Sm	11.3	α 1.96	7×10^{15}
^{176}Lu	2.59	β^- (1.188)	3.8×10^{10}
^{174}Hf	0.162	α	2×10^{15}
^{187}Re	62.60	β^- 0.0025	4.2×10^{10}
^{190}Pt	0.012	α	6.5×10^{11}

Values within parenthesis refer to decay energies.

Because of the long half-lives of these nuclides they must have been formed at the time of (or possibly even before) the formation of the solar system and of the earth. When the earth's crust solidified, these radionuclides became trapped in rocks. As they decayed, decay products accumulated in the closed rock environment. By measuring the amount of parent and daughter nuclides, it is possible with the half-life to calculate how long this environment (e.g. a rock formation) has existed. This is the bases for *nuclear dating* (also called "radioactive clocks"), and almost all of the nuclides in Table 5.2 can be used for this purpose. In § 5.8 we discuss dating methods for the K–Ar and Rb–Sr systems.

A careful look at these naturally occurring long-lived nuclei reveals that some of them appear in *short* decay series, e.g. $^{152}\text{Gd} \rightarrow ^{148}\text{Sm} \rightarrow ^{144}\text{Nd} \rightarrow ^{140}\text{Ce}$ and $^{190}\text{Pt} \rightarrow ^{186}\text{Os} \rightarrow ^{182}\text{W}$. The heavy element series beginning with U and Th isotopes are therefore referred to as *long* decay series.

5.2.2. Elements in the natural radioactive decay series

In Chapter 1 we briefly discussed the existence of four long series of genetically related radioactive nuclides beginning with Th, U or Np and ending with Pb or Bi. In Figure 5.1 we present all known isotopes of elements $_{81}\text{Tl}$ to $_{92}\text{U}$. Some of these nuclides occur naturally in the long decay series shown in Figure 2.1¹. Others are produced through nuclear reactions according to the schemes in Figure 4.8 and principles described in Ch. 12–15. The first series in Figure 1.2 is known as the *thorium decay series*, and consists of a group of radionuclides related through decay in which all the mass numbers are evenly divisible by four (the $4n$ series). It has its natural origin in ^{232}Th which occurs with 100% isotopic abundance. Natural thorium has a specific activity S of 4.06 MBq/kg, as its

¹ The student can easily trace the decay series in Fig. 5.1 with a transparent marker.

half-life through α -decay is 1.41×10^{10} y. The terminal nuclide in this decay series is the stable species ^{208}Pb (also known as ThD). The transformation from the original parent to the final product requires 6 α - and 4 β -decays. The longest-lived intermediate is 5.76 y ^{228}Ra .

The *uranium decay series* consist of a group of nuclides that, when their mass number is divided by 4, have a remainder of 2 (the $4n + 2$ series). The parent of this series is ^{238}U with a natural abundance of 99.3%; it undergoes α -decay with a half-life of 4.46×10^9 y. The stable end product of the uranium series is ^{206}Pb , which is reached after 8 α - and 6 β -decay steps.

The specific activity of ^{238}U is 12.44 MBq/kg ^{238}U . However, because *natural uranium* consists of 3 isotopes, ^{238}U , ^{235}U and ^{234}U , whose isotopic abundances are 99.2745%, 0.7200% and 0.0055%, respectively, the specific activity of natural uranium is 25.4 MBq/kg.

The uranium decay series provides the most important isotopes of elements radium, radon, and polonium, which can be isolated in the processing of uranium minerals. Each ton of uranium is associated with 0.340 g of ^{226}Ra . Freshly isolated ^{226}Ra reaches radioactive equilibrium with its decay products to ^{210}Pb in about two weeks (see Fig. 1.2). Many of these products emit energetic γ -rays, which resulted in the use of Ra as a γ -source in medical treatment of cancer (radiation therapy). However, the medical importance of radium has diminished greatly since the introduction of other radiation sources, and presently the largest use of radium is as small neutron sources (see Table 12.2).

Although the chemistry of radium is relatively simple (like barium), the fact that it produces a radioactive gas (radon) complicates its handling. The decay of radon produces "airborne" radioactive atoms of At, Po, Bi, and Pb. Since uranium is a common element in rocks (see §5.4) it is also a common constituent of building materials. Such material emits Rn, as discussed further in §5.6. Work with radium compounds should be carried out within enclosures to avoid exposure to Rn and its daughters.

The *actinium decay series* consists of a group of nuclides whose mass number divided by 4 leaves a remainder of 3 (the $4n + 3$ series). This series begins with the uranium isotope ^{235}U , which has a half-life of 7.04×10^8 y and a specific activity of 8×10^4 MBq/kg. The stable end product of the series is ^{207}Pb , which is formed after 7 α - and 4 β -decays. The actinium series includes the most important isotopes of the elements protactinium, actinium, francium, and astatine. Inasmuch as ^{235}U is a component of natural uranium, these elements can be isolated in the processing of uranium minerals. The longest-lived protactinium isotope, ^{231}Pa ($t_{1/2}$ 3.28×10^4 y) has been isolated on the 100 g scale, and is the main isotope for the study of protactinium chemistry. ^{227}Ac ($t_{1/2}$ 21.8 y) is the longest-lived actinium isotope.

5.3. Transuranic elements in nature and the Np decay series

A fourth long radioactive decay series, the *neptunium series* (Fig. 1.2), is composed of nuclides having mass numbers which divided by 4 have a remainder of 1 (the $4n + 1$ series). The name comes from the longest lived $A = 4n + 1$ nuclide heavier than Bi, ^{237}Np , which is considered as the parent species; it has a half-life of 2.14×10^6 y. Inasmuch as this half-life is considerably shorter than the age of the earth, primordial ^{237}Np no longer exists on earth, and, therefore, the neptunium series is not found as a natural

82Pb 207.2 α 0.171, 0.16	Pb 180 4 ms α 7.237	Pb 181 45 ms α 7.077	Pb 182 55 ms α 6.9217 β ⁻ 100	83Bi 208.9804 α 0.034, 0.19	Bi 185 44.1/5 α 6.037 β 1.597	Bi 186 9.6ms α 7.26 β 7.15	Bi 187 0.6ms α 7.05 β 0.99 γ 50	Bi 188 44ms α 7.01 β 0.62	Pb 187 15.2s α 6.19 β 0.06 γ 100 ... 72 c, γ	Pb 188 24.2 s α 5.98 β 0.78 γ 188/49 ... 9	Pb 189 51 s α 5.7204 β 0.99 γ 271 ...	Pb 190 2.2m α 5.110 β 100 m, γ 0.4	Pb 191 3.5 m α 5.112 β 100 γ 100, 9	Pb 192 3.5 m α 5.112 β 100 γ 100, 9	Pb 193 4.0m α 5.110 β 100 γ 332, γ 985	Pb 194 12.0 m α 4.64 β 100	Pb 195 16.0m α 4.64 β 100 γ 384	Pb 196 36.4 m α 4.64 β 100 γ 387 ...	84Po 2.4 ms α 7.337	Po 190 2.4 ms α 7.337	Po 191 27 ms α 7.337	Po 192 33.2 ms α 7.17/100	Po 193 0.45s α 7.00 β 100	Po 194 0.39 s α 8.848 β 100	Po 195 1.9 s α 8.70 β 100 γ 0.3	Po 196 5.8 s α 8.627 β 100 γ 0.2	Po 197 26s α 8.39 β 100 γ 43 g	Po 198 1.76 m α 8.185 β 67 γ 43 g	85At 0.18 s α 7.207	At 194 7 α 7.207	At 195 0.3 s α 7.065 β 97 γ 3	At 196 0.3 s α 7.065 β 97 γ 3	At 197 37 s α 6.71 β 96 γ 2 s	At 198 10s α 6.80 β 94 γ 2 s	At 199 7.2 s α 6.649	86Rn 3 ms α 7.462	Rn 196 3 ms α 7.462	Rn 197 19ms α 7.350 β 260 γ 9	Rn 198 64 ms α 7.205	Rn 199 0.32s α 7.05 β 7.00 γ 2	Rn 200 1.0 s α 6.902 β 96 γ 2	87Fr 19 ms α 7.388/100	Fr 200 19 ms α 7.388	Fr 201 48 ms α 7.388/100	88Ra 226.0254 α 7.86	Ra 202 0.7 ms α 7.86
---------------------------------------	----------------------------------	-----------------------------------	--	--	---	--	--	---	---	---	--	---	--	--	---	--	--	---	----------------------------------	------------------------------------	-----------------------------------	--	---	---	--	---	---	--	----------------------------------	-------------------------------	--	--	--	---	-----------------------------------	--------------------------------	----------------------------------	--	-----------------------------------	---	--	-------------------------------------	-----------------------------------	---------------------------------------	-----------------------------------	-----------------------------------

FIG. 5.1. Chart of all known isotopes of elements $_{81}\text{Tl}$ to $_{92}\text{U}$. The legend to the chart is given in Fig. 4.8.

Ra 203 33ms α 7.62 m	Ra 204 59 ms α 7.484 m	Ra 205 0.71s α 7.32 m	Ra 206 0.24s α 7.270 m	Ra 207 1.3s α 7.132 m	Ra 208 5ms α 7.132 m	Ac 207 22 ms α 7.76 m	Ac 208 354s α 7.76 m	Ac 209 90 ms α 7.350 m	91Po 231.0369 α 8.27 m	90Th 232.0381 α 7.40 m	90Th 37 ms α 7.79 m	Ac 210 0.35 s α 7.462 m	Ac 211 0.25 s α 7.487 m	Ac 212 0.93 s α 7.378 m	Ac 213 0.80 s α 7.364 m	Ac 214 8.2 s α 7.244 m	Ac 215 0.17 s α 7.805 m	Ac 216 0.33 s α 9.03 m	Ac 217 0.74 s α 9.985 m	Ac 218 1.1 μs α 9.206 m	Ac 219 11.8 μs α 8.854 m	Ac 220 28 ms α 100.738 m	Ac 221 52 ms α 100.746 m	Fr 202 0.34s α 7.24 m	Fr 203 0.55 s α 7.132 m	Fr 204 1.4s α 6.9 m	Fr 205 3.9 s α 6.919 m	Fr 206 0.7s α 6.9 m	Fr 207 14.8 s α 6.766 m	Fr 208 58.6 s α 6.646 m	Fr 209 50.0 s α 6.646 m	Fr 210 3.18 m α 6.643 m	Fr 211 3.10 m α 6.538 m	Fr 212 20.0 m α 6.432 m	Fr 213 34.6 s α 6.275 m	Fr 214 3.5 s α 6.275 m	Fr 215 0.09 μs α 6.310 m	Fr 216 16 μs α 6.310 m	Fr 217 2ms α 100.731 m	Fr 218 2ms α 100.731 m	Fr 219 21 ms α 100.731 m	At 201 3.5 s α 6.544 m	At 202 0.5 s α 6.2 m	At 203 7.4 m α 6.086 m	At 204 9.2 m α 5.951 m	At 205 28.2 m α 6.902 m	At 206 29.4 m α 6.769 m	At 207 1.8 h α 6.769 m	At 208 1.63 h α 6.641 m	At 209 5.41 h α 6.541 m	At 210 8.1 h α 6.324 m	At 211 7.22 h α 6.267 m	At 212 11.6 h α 6.160 m	At 213 0.11 μs α 6.056 m	At 214 760 μs α 6.056 m	At 215 0.1 ms α 6.056 m	At 216 7.2 s α 6.056 m	At 217 32.3 ms α 6.056 m	Po 199 4.2m α 6.06 m	Po 200 11.5 m α 5.803 m	Po 201 8.9 m α 5.76 m	Po 202 44.7 m α 5.580 m	Po 203 45s α 5.384 m	Po 204 3.53 h α 5.377 m	Po 205 1.66 h α 5.220 m	Po 206 8.8 d α 5.225 m	Po 207 28s α 5.116 m	Po 208 102 Y α 4.890 m	Po 209 138.376 d α 5.304 m	Po 210 138.376 d α 5.304 m	Po 211 26.5s α 4.656 m	Po 212 4.2 μs α 4.656 m	Po 213 4.2 μs α 4.656 m	Po 214 163.7 μs α 4.656 m	Po 215 1.780 ms α 4.656 m	Po 216 150 ms α 4.656 m	Bi 198 7.7 s α 5.494 m	Bi 199 31m α 5.494 m	Bi 200 1.72 h α 5.377 m	Bi 201 1.72 h α 5.377 m	Bi 202 1.72 h α 5.377 m	Bi 203 11.76 h α 5.116 m	Bi 204 11.22 h α 5.099 m	Bi 205 15.31 d α 5.099 m	Bi 206 6.24 d α 5.099 m	Bi 207 31.55 Y α 5.099 m	Bi 208 3.68 x 10 ⁴ Y α 5.099 m	Bi 209 100 % α 5.099 m	Bi 210 2.17 m α 4.987 m	Bi 211 2.17 m α 4.987 m	Bi 212 45.59 m α 4.987 m	Bi 213 45.59 m α 4.987 m	Bi 214 19.9 m α 4.987 m	Pb 197 1.4h α 6.81 m	Pb 198 3.8h α 6.81 m	Pb 199 12.2m α 6.81 m	Pb 200 21.5 h α 6.81 m	Pb 201 1.02m α 6.81 m	Pb 202 3.62h α 6.81 m	Pb 203 8.3s α 6.81 m	Pb 204 1.4 s α 6.81 m	Pb 205 1.4 s α 6.81 m	Pb 206 24.1 % α 6.81 m	Pb 207 52.4 % α 6.81 m	Pb 208 22.3 Y α 6.81 m	Pb 209 3.253 h α 6.81 m	Pb 210 138.376 d α 6.81 m	Pb 211 36.1 m α 6.81 m	Pb 212 10.64 h α 6.81 m	Pb 213 10.2 m α 6.81 m	Pb 214 26.8 m α 6.81 m	Pb 215 7.6 m α 6.81 m	Pb 216 150 ms α 6.81 m	Pb 217 150 ms α 6.81 m	Pb 218 35 ms α 6.81 m	Pb 219 10 ms α 6.81 m	Pb 220 25.6 μs α 6.81 m	Pb 221 1.68 μs α 6.81 m	Pb 222 1.68 μs α 6.81 m	Pb 223 4.3 ms α 6.81 m	Pb 224 4.3 ms α 6.81 m	Th 201 1.68 ms α 100.8 m	Th 202 1.68 ms α 100.8 m	Th 203 1.68 ms α 100.8 m	Th 204 1.68 ms α 100.8 m	Th 205 1.68 ms α 100.8 m	Th 206 1.68 ms α 100.8 m	Th 207 1.68 ms α 100.8 m	Th 208 1.68 ms α 100.8 m	Th 209 1.68 ms α 100.8 m	Th 210 1.68 ms α 100.8 m	Th 211 1.68 ms α 100.8 m	Th 212 1.68 ms α 100.8 m	Th 213 1.68 ms α 100.8 m	Th 214 1.68 ms α 100.8 m	Th 215 1.68 ms α 100.8 m	Th 216 1.68 ms α 100.8 m	Th 217 1.68 ms α 100.8 m	Th 218 1.68 ms α 100.8 m	Th 219 1.68 ms α 100.8 m	Th 220 1.68 ms α 100.8 m	Th 221 1.68 ms α 100.8 m	Th 222 1.68 ms α 100.8 m	Th 223 1.68 ms α 100.8 m	Th 224 1.68 ms α 100.8 m	U 201 3.5 s α 6.544 m	U 202 6.5 s α 6.544 m	U 203 7.0 s α 6.544 m	U 204 7.4 m α 6.086 m	U 205 9.2 m α 5.951 m	U 206 28.2 m α 6.902 m	U 207 1.8 h α 6.769 m	U 208 1.63 h α 6.641 m	U 209 5.41 h α 6.541 m	U 210 8.1 h α 6.324 m	U 211 7.22 h α 6.267 m	U 212 11.6 h α 6.160 m	U 213 0.11 μs α 6.056 m	U 214 760 μs α 6.056 m	U 215 0.1 ms α 6.056 m	U 216 7.2 s α 6.056 m	U 217 32.3 ms α 6.056 m	U 218 4.2m α 6.06 m	U 219 11.5 m α 5.803 m	U 220 8.9 m α 5.76 m	U 221 44.7 m α 5.580 m	U 222 45s α 5.384 m	U 223 3.53 h α 5.377 m	U 224 8.8 d α 5.225 m	U 225 8.8 d α 5.225 m	U 226 28s α 5.116 m	U 227 28s α 5.116 m	U 228 31m α 5.494 m	U 229 31m α 5.494 m	U 230 1.72 h α 5.377 m	U 231 1.72 h α 5.377 m	U 232 1.72 h α 5.377 m	U 233 45s α 5.384 m	U 234 44.7 m α 5.580 m	U 235 4.2m α 6.06 m	U 236 4.2m α 6.06 m	U 237 4.2m α 6.06 m	U 238 4.2m α 6.06 m	U 239 4.2m α 6.06 m	U 240 4.2m α 6.06 m	U 241 4.2m α 6.06 m	U 242 4.2m α 6.06 m	U 243 4.2m α 6.06 m	U 244 4.2m α 6.06 m	U 245 4.2m α 6.06 m	U 246 4.2m α 6.06 m	U 247 4.2m α 6.06 m	U 248 4.2m α 6.06 m	U 249 4.2m α 6.06 m	U 250 4.2m α 6.06 m	U 251 4.2m α 6.06 m	U 252 4.2m α 6.06 m	U 253 4.2m α 6.06 m	U 254 4.2m α 6.06 m	U 255 4.2m α 6.06 m	U 256 4.2m α 6.06 m	U 257 4.2m α 6.06 m	U 258 4.2m α 6.06 m	U 259 4.2m α 6.06 m	U 260 4.2m α 6.06 m	U 261 4.2m α 6.06 m	U 262 4.2m α 6.06 m	U 263 4.2m α 6.06 m	U 264 4.2m α 6.06 m	U 265 4.2m α 6.06 m	U 266 4.2m α 6.06 m	U 267 4.2m α 6.06 m	U 268 4.2m α 6.06 m	U 269 4.2m α 6.06 m	U 270 4.2m α 6.06 m	U 271 4.2m α 6.06 m	U 272 4.2m α 6.06 m	U 273 4.2m α 6.06 m	U 274 4.2m α 6.06 m	U 275 4.2m α 6.06 m	U 276 4.2m α 6.06 m	U 277 4.2m α 6.06 m	U 278 4.2m α 6.06 m	U 279 4.2m α 6.06 m	U 280 4.2m α 6.06 m	U 281 4.2m α 6.06 m	U 282 4.2m α 6.06 m	U 283 4.2m α 6.06 m	U 284 4.2m α 6.06 m	U 285 4.2m α 6.06 m	U 286 4.2m α 6.06 m	U 287 4.2m α 6.06 m	U 288 4.2m α 6.06 m	U 289 4.2m α 6.06 m	U 290 4.2m α 6.06 m	U 291 4.2m α 6.06 m	U 292 4.2m α 6.06 m	U 293 4.2m α 6.06 m	U 294 4.2m α 6.06 m	U 295 4.2m α 6.06 m	U 296 4.2m α 6.06 m	U 297 4.2m α 6.06 m	U 298 4.2m α 6.06 m	U 299 4.2m α 6.06 m	U 300 4.2m α 6.06 m
-------------------------------	---------------------------------	--------------------------------	---------------------------------	--------------------------------	-------------------------------	--------------------------------	-------------------------------	---------------------------------	---------------------------------	---------------------------------	------------------------------	----------------------------------	----------------------------------	----------------------------------	----------------------------------	---------------------------------	----------------------------------	---------------------------------	----------------------------------	----------------------------------	-----------------------------------	-----------------------------------	-----------------------------------	--------------------------------	----------------------------------	------------------------------	---------------------------------	------------------------------	----------------------------------	----------------------------------	----------------------------------	----------------------------------	----------------------------------	----------------------------------	----------------------------------	---------------------------------	-----------------------------------	---------------------------------	---------------------------------	---------------------------------	-----------------------------------	---------------------------------	-------------------------------	---------------------------------	---------------------------------	----------------------------------	----------------------------------	---------------------------------	----------------------------------	----------------------------------	---------------------------------	----------------------------------	----------------------------------	-----------------------------------	----------------------------------	----------------------------------	---------------------------------	-----------------------------------	-------------------------------	----------------------------------	--------------------------------	----------------------------------	-------------------------------	----------------------------------	----------------------------------	---------------------------------	-------------------------------	---------------------------------	-------------------------------------	-------------------------------------	---------------------------------	----------------------------------	----------------------------------	------------------------------------	------------------------------------	----------------------------------	---------------------------------	-------------------------------	----------------------------------	----------------------------------	----------------------------------	-----------------------------------	-----------------------------------	-----------------------------------	----------------------------------	-----------------------------------	--	---------------------------------	----------------------------------	----------------------------------	-----------------------------------	-----------------------------------	----------------------------------	-------------------------------	-------------------------------	--------------------------------	---------------------------------	--------------------------------	--------------------------------	-------------------------------	--------------------------------	--------------------------------	---------------------------------	---------------------------------	---------------------------------	----------------------------------	------------------------------------	---------------------------------	----------------------------------	---------------------------------	---------------------------------	--------------------------------	---------------------------------	---------------------------------	--------------------------------	--------------------------------	----------------------------------	----------------------------------	----------------------------------	---------------------------------	---------------------------------	-----------------------------------	-----------------------------------	-----------------------------------	-----------------------------------	-----------------------------------	-----------------------------------	-----------------------------------	-----------------------------------	-----------------------------------	-----------------------------------	-----------------------------------	-----------------------------------	-----------------------------------	-----------------------------------	-----------------------------------	-----------------------------------	-----------------------------------	-----------------------------------	-----------------------------------	-----------------------------------	-----------------------------------	-----------------------------------	-----------------------------------	-----------------------------------	--------------------------------	--------------------------------	--------------------------------	--------------------------------	--------------------------------	---------------------------------	--------------------------------	---------------------------------	---------------------------------	--------------------------------	---------------------------------	---------------------------------	----------------------------------	---------------------------------	---------------------------------	--------------------------------	----------------------------------	------------------------------	---------------------------------	-------------------------------	---------------------------------	------------------------------	---------------------------------	--------------------------------	--------------------------------	------------------------------	------------------------------	------------------------------	------------------------------	---------------------------------	---------------------------------	---------------------------------	------------------------------	---------------------------------	------------------------------	------------------------------	------------------------------	------------------------------	------------------------------	------------------------------	------------------------------	------------------------------	------------------------------	------------------------------	------------------------------	------------------------------	------------------------------	------------------------------	------------------------------	------------------------------	------------------------------	------------------------------	------------------------------	------------------------------	------------------------------	------------------------------	------------------------------	------------------------------	------------------------------	------------------------------	------------------------------	------------------------------	------------------------------	------------------------------	------------------------------	------------------------------	------------------------------	------------------------------	------------------------------	------------------------------	------------------------------	------------------------------	------------------------------	------------------------------	------------------------------	------------------------------	------------------------------	------------------------------	------------------------------	------------------------------	------------------------------	------------------------------	------------------------------	------------------------------	------------------------------	------------------------------	------------------------------	------------------------------	------------------------------	------------------------------	------------------------------	------------------------------	------------------------------	------------------------------	------------------------------	------------------------------	------------------------------	------------------------------	------------------------------	------------------------------

FIG. 5.1. Continued from previous page.

U 225 95 ms α 7.88 ...	U 226 0.2 s α 7.87 ...	U 227 1.1 m α ₁ 100 6.86 ... γ 247 ...	U 228 9.1 m α ₁ >95 6.681/70 ... c<5, γ 99.2 ...	U 229 58 m α ₁ -20 6.362/94 ... c-80, γ 1.23 ...	U 230 20.8 d α ₁ 100 6.888/97 α ₂ 100 5.320 158 ... 16810.2 84γ 4270.06	U 231 4.2 d α 5.456/0.006 α ₂ 99.985 50.0007 ... 6.9 0.6 ... 10, γ ...	U 232 68.9 y α ₁ -100 5.320 158 ... 16810.2 84γ 4270.06	U 233 1.59 × 10 ⁵ y α ₁ -100 4.824 158 ... 16810.2 84γ 4270.06	U 234 0.0055 % 2.46 × 10 ⁵ y α ₁ 100 4.735/73	U 235 0.7200 % 7.04 × 10 ⁸ y α ₁ -100 4.398	U 236 2.34 × 10 ⁷ y α ₁ 100 4.496/74 β 0.2 .../100 γ 60.33 ...	U 237 6.75 d α 4.47 × 10 ⁶ y β 0.2 .../100 γ 60.33 ...	U 238 99.2745 % 4.47 × 10 ⁹ y α ₁ 100 4.199/77	U 239 23.5 m β 1.2 .../100 γ 75.52 ...	U 240 14.1 h β 0.4 .../100 γ 44.2 ...	U 242 16.8 m β ₁ 100 γ 58.9 ...		
Pa 224 0.95 s α ₁ 100 7.656 ...	Pa 225 1.8 s α ₁ 100 7.245/70 α ₂ 74 6.883/39 ... c/28	Pa 226 1.8 m α ₁ 100 6.863/39 α ₂ 74 6.883/39 ... c/28	Pa 227 38.3 m α ₁ -2 6.078 ... c/-98, β ⁺ 70.2 ... c-13	Pa 228 22 h α ₁ -2 6.078 ... c/-98, β ⁺ 70.2 ... c-13	Pa 229 1.50 d α ₁ 100 5.980 α ₂ 26 5.980 0.09 ... c/99 75 γ ...	Pa 230 17.4 d α ₁ 100 5.345 α ₂ 100 5.014/25 α ₃ -0.2 ... γ 27.9	Pa 231 3.28 × 10 ⁴ y α ₁ 100 5.014/25 α ₂ -0.2 ... γ 27.9	Pa 232 1.31 d α ₁ -0.2 ... γ 0.3	Pa 233 27.0 d β 0.3 .../100 γ 31.2/96 ...	Pa 234 1.7m 6.7m 1/100 13 0.3 β 1.4 .../100 γ 28.37 1/11	Pa 235 24.2 m β 1.4 .../100 γ 1.28 ...	Pa 236 9.1 m β 2.0 .../100 γ 64.2/29 ...	Pa 237 8.7 m β 1.4 .../100 γ 854/34 ...	Pa 238 2.3 m β 1.7 .../100 γ 10.15 ...				
Th 223 0.66 s α ₁ 100 7.287/80 α ₂ 140 ...	Th 224 1.04 s α ₁ 100 7.170/79 α ₂ -90 6.479 ... c/-10	Th 225 8.72 m α ₁ -90 6.479 ... c/-10	Th 226 31 m α ₁ 100 6.336/76 ... γ 111/3 ...	Th 227 18.72 d α ₁ 100 6.038/75 ... γ 84/1 ...	Th 228 1.913 y α ₁ 100 5.423/73 α ₂ 100 4.845/56 ... γ 194/5 ...	Th 229 7880 y α ₁ 100 4.845/56 ... γ 194/5 ...	Th 230 7.54 × 10 ⁴ y α ₁ 100 4.845/56 ... γ 194/5 ...	Th 231 1.063 d β 0.3 .../100 γ 26.15 ...	Th 232 1.41 × 10 ¹⁰ y α ₁ 100 4.010/77 ... γ	Th 233 22.3 m β 1.2 .../100 γ 28.2/6 ...	Th 234 24.10 d β 0.2 .../100 γ 6.34 ...	Th 235 7.1 m β 1.4 .../100 γ 4.17 ...	Th 236 37.5 m β 1.0 .../100 γ 11.1/4 ...	Th 237 5.0 m β ₁ 100				
Ac 222 1.09m 50k α ₁ -789 0/100 6.81 7.01 ... c/-24 794	Ac 223 2.10 m α ₁ 100 6.474/44 ... c/-10 6.138 ... c/-80	Ac 224 2.9 h α ₁ -10 6.138 ... c/-80	Ac 225 10.0 d α ₁ 100 5.830/52 ... γ 100/2 ...	Ac 226 1.24 α ₁ 100 5.396/0.008 ... c/17	Ac 227 21.773 y α ₁ 100 4.845/56 ... c/17	Ac 228 6.13 h α ₁ 100 4.845/56 ... c/17	Ac 229 1.045 h α ₁ 100 4.845/56 ... c/17	Ac 230 2.03 m β 2.2 .../100 γ 45.5/9 ...	Ac 231 7.5 m β ₁ 100 γ 28.3	Ac 232 1.98 m β ₁ 100 γ 68.5	Ac 233 2.42 m β ₁ 100 γ 5.23 ...	Ac 234 44 s β ₁ 100 γ 184/7 ...						
Ra 221 28 s α ₁ 100 6.513/38 α ₂ -100 6.566 ... γ 90/18 ...	Ra 222 38.0 s α ₁ -100 6.716 ... γ 324/2 ...	Ra 223 11.43 d α ₁ -100 6.846 ... γ 241/4 ...	Ra 224 3.66 d α ₁ -100 6.846 ... γ 241/4 ...	Ra 225 14.8 d α ₁ -100 6.846 ... γ 40/29	Ra 226 1600 y α ₁ 100 4.784/94 ... γ 186/3 ...	Ra 227 42.2 m α ₁ 100 4.784/94 ... γ 186/3 ...	Ra 228 5.75 y α ₁ 100 4.784/94 ... γ 186/3 ...	Ra 229 4.0 m β ⁺ 1.8/100 γ 14 ...	Ra 230 1.55 h β ⁺ 0.8 .../100 γ 7.2 ...	Ra 231 1.72 m β ⁺ 100 γ 41.0 ...	Ra 232 4.2 m β ⁺ 100 γ 47.1 ...	Ra 233 30 s β ⁺ 100	Ra 234 30 s β ⁺ 100					
Fr 220 27.4 s α ₁ 99.6 6.686 β ₁ 0.4, γ 95.2	Fr 221 4.9 m α ₁ 100 6.341/83 ... γ 218/11 ...	Fr 222 14.2 m α ₁ <1 ... β 1.8 .../99	Fr 223 21.8 m α ₁ 6.340/0.008 ... β 1.1 .../99.994	Fr 224 3.3 m β ⁺ 2.6 .../100 γ 182 ...	Fr 225 4.0 m β ⁺ 1.6/100 γ 182 ...	Fr 226 48 s β ⁺ 3.2 .../100 γ 284 ...	Fr 227 2.47 m β ⁺ 1.8 .../100 γ 90 ...	Fr 228 39 s β ⁺ 1.8 .../100 γ 474 ...	Fr 229 50.2 s β ⁺ 100 γ 310 ...	Fr 230 19.1 s β ⁺ 100 γ 71.1 ...	Fr 231 17.5 s β ⁺ 100 γ 4.3 ...	Fr 232 5 s β ⁺ 100 γ 1.28						
Rn 219 3.96 s α ₁ 100 6.819/81 ... β 288/99.83	Rn 220 55.6 s α ₁ 100 6.272 6.937/18 ... β 370.8 .../78	Rn 221 25 m α ₁ 100 5.980 ... β 99.9 ...	Rn 222 3.825 d α ₁ 100 5.980 ... β 99.9 ...	Rn 223 23.2 m α ₁ 100 5.980 ... β 99.9 ...	Rn 224 1.78 h α ₁ 100 5.980 ... β 99.9 ...	Rn 225 4.5 m β ₁ 100 γ 29	Rn 226 7.4 m β ₁ 100 γ 192	Rn 227 22.5 s β ₁ 100 γ 182	Rn 228 1.08 m β ₁ 100 γ 1.25									
At 218 -2 s α ₁ 99.9 6.695/90	At 219 54 s α ₁ 6.275/97 β ₁ 3	At 220 3.71 m α ₁ 5.493/8 β ₁ 92	At 221 2.3 m β ₁ 100	At 222 54 s β ₁ 100	At 223 50 s β ₁ 100													
Po 217 < 10 s α ₁ -100 6.002/100	Po 218 3.05 m α ₁ -100 6.002/100																	
Bi 216 3.6 m β ₁ 7 γ 550/7 ...																		

FIG. 5.1. Continued from previous page.

occurrence. However, Np has been discovered in the spectrum of some stars. All known Np-isotopes are presented in Figure 16.1.

Very small amounts of ^{237}Np , as well as of ^{239}Pu , have been discovered on earth; the half-lives of ^{239}Pu (in the $4n + 3$ series) is 2.411×10^4 y. Both isotopes are too short-lived to have survived the 4 eons since the solar system was formed. However, they are always found in minerals containing uranium and thorium and it is believed that the neutrons produced in these minerals through (α, n) and (γ, n) reactions with U and Th as well as by spontaneous fission of ^{238}U form the neptunium and plutonium through n-capture and β -decay processes. The n-production rate in the uranium mineral pitchblende (containing $\sim 50\%$ U) is about 50 n/kg s. The typical value for the $^{239}\text{Pu}/^{238}\text{U}$ ratio in minerals is 3×10^{-12} .

The end product of the neptunium series is ^{209}Bi , which is the only stable isotope of bismuth. Seven α - and four β -decays are required in the sequence from the parent ^{237}Np to ^{209}Bi . An important nuclide in the neptunium decay series is the uranium isotope ^{233}U , which has a half-life of 1.59×10^5 y (the most stable intermediate) and, like ^{235}U , is fissionable by slow neutrons.

The long-lived plutonium isotope ^{244}Pu (belonging to the $4n$ series; see also Fig. 16.1), which decays through α -emission and spontaneous fission (0.13%) with a total half-life of 8.26×10^7 y, was discovered in rare earth minerals in 1971. If this is a survival of primeval ^{244}Pu , only $10^{-15}\%$ of the original can remain. An alternate possibility is that this ^{244}Pu is a contaminant from cosmic dust (e.g. from a supernova explosion in more recent times than the age of the solar system).

5.4. Thorium

5.4.1. Isotopes

Natural thorium consists 100% of the isotope ^{232}Th which is the parent nuclide of the thorium decay series. The specific radioactivity for thorium is lower than that of uranium, and it is normally treated as a non-radioactive element. For radioactive tracer studies the nuclide ^{234}Th ($t_{1/2}$ 24.1 d) is used after separation from natural uranium.

5.4.2. Occurrence and production

Thorium is somewhat more common in nature than uranium, with an average content in the earth's crust of 10 ppm (by comparison the average abundance of lead is about 16 ppm in the earth's crust). In minerals it occurs only as oxide. The content of thorium in sea water is $< 0.5 \times 10^{-3}$ g/m³, which is lower than that of uranium because of the lower solubility of Th^{4+} compounds (the most stable valency state of Th).

The most common thorium mineral is monazite, a golden brown rare earth phosphate containing 1 - 15% ThO_2 and usually 0.1 - 1% U_3O_8 . It is also found in small amounts in granite and gneiss. The largest deposits of monazite are found in India, Egypt, South Africa, the USA, and Canada, with 200 - 400 kton ThO_2 in each country. The size of natural resources are defined in terms of ore reserves which can be economically processed. Thus, the total reserves at commercial price in 1991 was estimated to > 2 Mt ThO_2 .

Because thorium often occurs with other valuable metals (in addition to the lanthanides) such as niobium, uranium and zirconium, it can be produced as a byproduct.

The following procedure is used for producing thorium from monazite sand. The sand is digested with hot concentrated alkali which converts the oxide to hydroxide. The filtered hydroxide is dissolved in hydrochloric acid and the pH adjusted between 5 and 6, which precipitates the thorium hydroxide but not the main fraction of lanthanide elements. The thorium hydroxide is dissolved in nitric acid and selectively extracted with methyl isobutyl ketone or tributyl phosphate in kerosene. This gives a rather pure organic solution of $\text{Th}(\text{NO}_3)_4$. The thorium is stripped from the organic phase by washing with alkali solution.

5.4.3. *Uses*

Thorium metal is used as electrode material in gas discharge lamps, and as getter for absorption of rest gases in high vacuum technique. ThO_2 (melting point 3300°C) is highly refractory and used for high temperature furnace linings. Thorium salts are of little practical use. Because Th^{4+} is a stable tetravalent ion with properties very similar to the tetravalent actinides, Th^{4+} is often used as an analog for the An(IV) ions; most common to use are ^{228}Th (1.91 y) or ^{230}Th (7.54×10^4 y) and ^{234}Th ($t_{1/2}$ 24.5 d), which can be isolated from old ^{232}Th or ^{238}U , see Fig. 1.2. Thorium may become important to the nuclear energy industry as a fuel in high temperature gas-cooled reactors and may be used in the future in thorium-breeder reactors (Ch. 20).

5.5. Uranium

5.5.1. *Isotopes*

Natural uranium consists of 3 isotopes, ^{234}U , ^{235}U and ^{238}U , members of the natural decay series discussed in §5.2.2. Uranium is an important raw material for nuclear energy production (see Ch. 19 and 21).

The specific radioactivity of natural uranium makes it a weak radiological hazard (see Ch. 18). It is also chemically toxic and precautions should be taken against inhaling uranium dust for which the threshold limit is 0.20 mg/m^3 air (about the same as for lead).

5.5.2. *Occurrence, resources and production capacity*

Uranium appears in a large number of minerals (at least 60 are known). The earth's crust contains 3 - 4 ppm U, which makes it about as abundant as arsenic or boron. Uranium is found at this relative concentration in the large granitic rock bodies formed by slow cooling of the magma about 1.7 - 2.5 eons ago (1 eon = 10^9 y = 1 billion years). It is also found in younger rocks at higher concentrations ("ore bodies").

Geochemists now begin to understand how these ore bodies were formed. They are usually located downstream from mountain ranges. As the atmosphere became oxidizing about 1.7 eons ago, rain penetrated into rock fractures and pores, bringing the uranium to

its hexavalent state and dissolving it as an anionic complex (likely as a carbonate, $\text{UO}_2(\text{CO}_3)_n^{2-2n}$, or as a sulphate complex, $\text{UO}_2(\text{SO}_4)_n^{2-2n}$), often at elevated temperatures. As the water and the dissolved uranium migrated downstream, regions of reducing material were encountered, either inorganic (e.g. pyrite) or organic (e.g. humic) matter, which caused reduction to U(IV). Since most U(IV) compounds are insoluble, the uranium precipitated, possibly as the sulphide or, more likely, as the hydroxide. Many of these original uranium precipitates were later covered by sedimentary material.

In most minerals uranium is in the tetravalent state. The most important one is uraninite (UO_{2+x} , $x = 0.01$ to 0.25), in which the uranium concentration is 50 - 90%; it is found in Western Europe, Central Africa (e.g. Katanga, Gabon) and Canada (e.g. Cigar Lake) and Australia (e.g. Koongara). In the USA and Russia carnotite (a K + U vanadate) is the most important mineral and contains 54% uranium. In the high grade ores the mineral is mixed with other minerals so the average uranium concentration in the crushed ore is much less: e.g. $\leq 0.5\%$ on the Colorado Plateau. Uranium is often found in lower concentration, of the order of 0.01 - 0.03%, in association with other valuable minerals such as apatite, shale, peat, etc.

At the 1999 price of $\sim \$30$ per kg U, the known (total of *measured*, *indicated* and *inferred*) world reserves of uranium which could be recovered economically was about 3.3 Mton U_3O_8 . This corresponds to ~ 40 years consumption assuming LWR:s and present nuclear capacity to increase by $\sim 1\%$ a year. As energy cost increases, it is estimated that about 20 Mton can be recovered at a higher cost. Sea water contains some 4 500 Mtons U but it is uncertain if U can be recovered economically from this huge resource.

The uranium production in 1999 was ~ 37 kton of U_3O_8 . The ten largest producers, in decreasing order, were Canada, Australia, Niger, Namibia, Uzbekistan, Russia, USA, Kazakhstan, South Africa and the Czech Republic. The Cigar Lake mine in Canada is interesting for its location (430 m below a lake), size (~ 130 kton U), and high U-content (up to 19%) which poses a difficult working environment (Rn plus quite high levels of γ -radiation); the mine is expected to open in 2005. The past over capacity in U-production has caused large U stockpiles and a small interest in prospecting and opening of new mines.

5.5.3. Production techniques

Uranium ores differ widely in composition, containing a variety of other elements which must be removed. As a result the production methods differ considerably depending on the particular ore to be processed although in every case very selective processes must be used. The following is a common scheme.

The ore is mined in open pits or underground. The ore is crushed and concentrated through flotation. If the uranium is in the tetravalent state it is oxidized in piles by air, sometimes with the aid of bacteria. The material is subsequently treated with sulfuric acid which dissolves the uranium as the sulphate complex, $\text{UO}_2(\text{SO}_4)_2^{2-}$ (the *feed*). This complex can be selectively removed from the aqueous solution by means of *anion exchange* resins or, more commonly, by extraction into an organic solvent (*solvent extraction*). In the latter case an *extractant* (i.e. an organic compound with ability to form a U-organic complex soluble in organic solvents) dissolved in kerosene is used; depending on the aqueous feed composition, various extractants have been applied. A typical flow-sheet is illustrated in Figure 5.2, and the basic chemical principles in Table 5.3. The final product is commonly

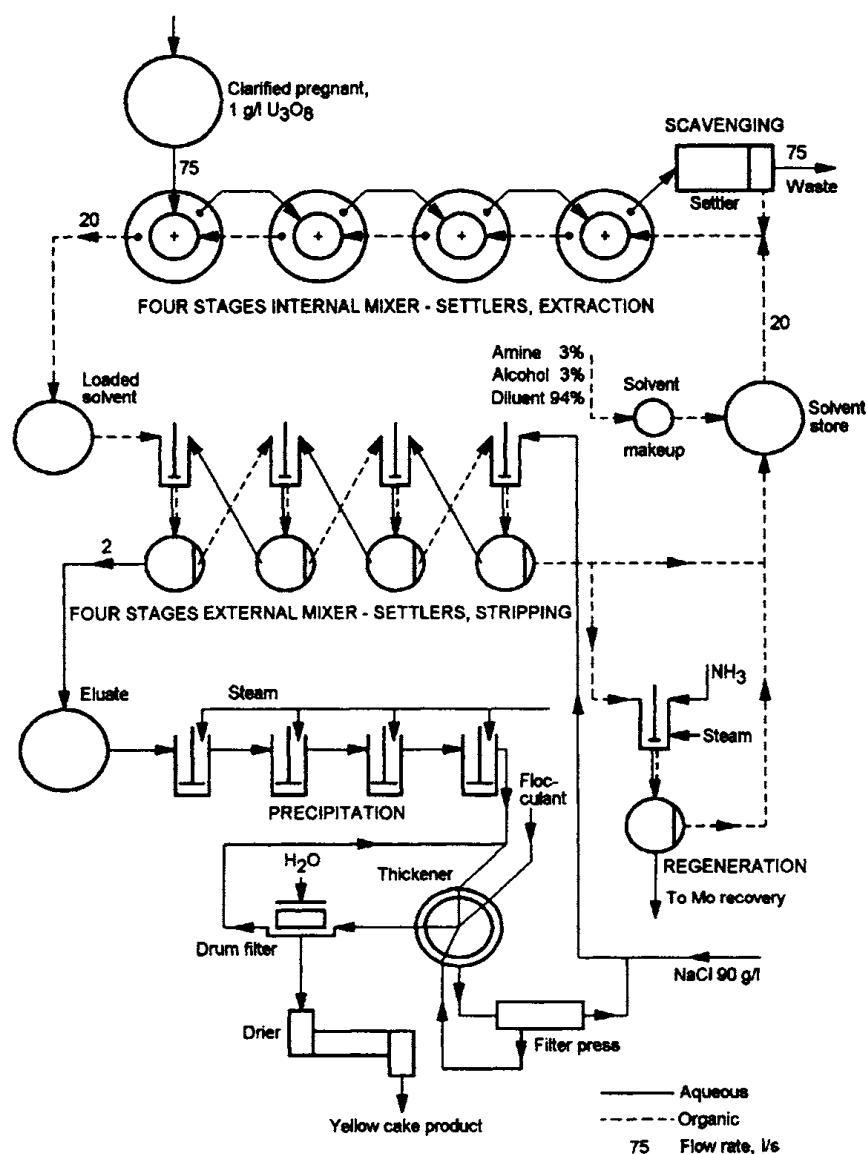

FIG. 5.2. Amine extraction circuit, Kerr-McGee Corp., Grants Mill, New Mexico. Each S-X battery consists of 4 mixer-settlers. Solid lines aqueous, dashed lines organic flow. Numbers are flow rates (l/s).

ammonium diuranate, which is referred to as *yellow cake*; it contains 65-70% U. It is so free of radioactive uranium daughters that it can be handled safely in drums without any radiation protection. Yellow cake is further purified in order to obtain a final pure product of U_3O_8 , usually better than 99.98% pure; its content of neutron poisons (nuclides which have high capture cross-sections for neutrons such as B, Cd, Dy; see Ch. 19) is less than 0.00002%.

Heating yellow cake in hydrogen gas produces UO_2 which in sintered form is used as nuclear reactor fuel. If the UO_2 is exposed to F_2 , UF_4 is obtained ("green salt"), which in a thermite process with calcium metal yields metallic uranium. The metal is slowly oxidized in air at room temperature; the metal powder is very reactive at elevated temperatures and can then be used to remove practically all impurities from rare gases.

TABLE 5.3. Chemical bases for the Amex (amine) and Dapex (HDEHP) processes for uranium recovery from sulfuric acid leach liquors. (From Musicas and Schulz.)

	AMEX	DAPEX
Extraction	$\text{UO}_2^{2+} + \text{SO}_4^{2-} + 2(\text{R}_3\text{NH})_2\text{SO}_4 \rightleftharpoons$ $(\text{R}_3\text{NH})_4\text{UO}_2(\text{SO}_4)_3$ $\text{R}_3\text{N} = \text{Alamine 336 or}$ $\text{Adogen 364 (trialkylamines}$ $\text{with alkyl groups with}$ $8 - 10 \text{ carbons)}$	$\text{UO}_2^{2+} + 2(\text{HDEHP})_2 \rightleftharpoons$ $\text{UO}_2(\text{HDEHP}.\text{DEHP})_2 + 2\text{H}^+$
Stripping	<p>Acidic stripping</p> $(\text{R}_3\text{NH})_4\text{UO}_2(\text{SO}_4)_3 + 4\text{HX} \rightleftharpoons$ $4\text{R}_3\text{NHX} + \text{UO}_2^{2+} + 3\text{HSO}_4^- + \text{H}^+$ $\text{HX} = \text{HCl or HNO}_3$ <p>Neutral stripping</p> $(\text{R}_3\text{NH})_4\text{UO}_2(\text{SO}_4)_3 + (\text{NH}_4)_2\text{SO}_4 +$ $4 \text{NH}_3 \rightleftharpoons 4\text{R}_3\text{N} + \text{UO}_2(\text{SO}_4)_3^{4-} +$ $6\text{NH}_4^+ + \text{SO}_4^{2-}$ <p>Alkaline stripping</p> $(\text{R}_3\text{NH})_4\text{UO}_2(\text{SO}_4)_3 + 7\text{Na}_2\text{CO}_3 \rightleftharpoons$ $4\text{R}_3\text{N} + \text{UO}_2(\text{CO}_3)_3^{4-} + 4\text{HCO}_3^- +$ $3\text{SO}_4^{2-} + 14\text{Na}^+$	<p>Alkaline stripping</p> $\text{UO}_2(\text{HDEHP}.\text{DEHP})_2 + 4\text{Na}_2\text{CO}_3 \rightleftharpoons$ $\text{UO}_2(\text{CO}_3)_3^{4-} + 4\text{NaDEHP} + \text{H}_2\text{O} +$ $\text{CO}_2 \uparrow + 4\text{Na}^+$ <p>(TBP must be added to avoid the third phase formation owing to low organic phase solubility of NaDEHP.)</p> <p>Acidic stripping</p> $\text{UO}_2(\text{HDEHP}.\text{DEHP})_2 + 2\text{H}^+ \rightleftharpoons$ $2(\text{HDEHP})_2 + \text{UO}_2^{2+}$

The chemistry of aqueous uranium is discussed in §16.3 together with the chemistry of the other actinides. Production of reactor fuel and reprocessing is described in Chapter 21.

5.5.4. Production wastes

The milling operation produces tailings consisting of fine-coarse particles in a water slurry containing most of the radioactive uranium decay products, of which radium is the most hazardous. As most tailings are not highly radioactive (e.g. from mining of low grade ores) they are dumped on outside the plant; leach water from the dumps will then, combined with mine water, enter local streams. In dry areas, dusts from the tailings may spread by winds.

This is the main picture and explains the high dose commitment values in Table 22.1. However, many health authorities now require conditioning of the tailings to reduce harmful effects to the environment: recycling of waste water, precipitation and removal of radium from solution, and neutralization to precipitate heavy metals. The slurry is usually transported to an impoundment basin where the solid particles settle out, and the effluent is treated for removal of activities before discharge into a settling pond. Treatment ponds may contain low permeability liners where appropriate to control seepage. Barium chloride may be added to the tailings to precipitate dissolved ^{226}Ra as Ra-Ba sulfate. Lime and limestone may be added to the tailings to raise pH.

The final dry waste is stored either on surface or in shallow basins, though underground storage also has been practiced (abandoned mines). In the former case, the tailings are covered by up to 3 meters of earth fill to restrict erosion, and some water tight material to protect it against rain. In some cases (e.g. Sweden) the land on top of mine waste and tailings have been reclaimed for farming.

5.6. Radium and radon in the environment

In uranium ore radioactive equilibrium is established between the mother ^{238}U and daughters in the decay chain (see heavy arrow in Fig. 5.1, $4n + 2$ series) at *the rate of the daughter half-life* and at *the level of the mother decay rate*. The chain passes ^{226}Ra and ^{222}Rn and daughters down to ^{206}Pb at a rate corresponding to the original amount of ^{238}U , as long as the host material is undisturbed. The equilibrium between ^{226}Ra and ^{210}Pb is established within some weeks. Since ^{222}Rn is a gaseous intermediate, its daughters are likely to be formed in air ("radon daughters"). Radon diffuses out of thorium and uranium minerals, and adds radioactivity to the ground water and to the atmosphere both by its own presence and that of its daughters. Since Ra and Rn are among the most radio-toxic substances existing, causing bone and lung cancer at relatively low concentrations (the risk levels are discussed in Ch. 18), special attention must be devoted to their appearance in nature.

Common Rn-concentrations in ground water are 5 - 300 kBq/m³, but in areas of U-rich granite values $\gg 1$ MBq $^{222}\text{Rn}/\text{m}^3$ occur. Tap water usually contains of the order of 1 kBq/m³. In many places water from hot mineral wells is considered beneficial to health both for bathing and for drinking ("spas" or hot springs). The water may be warm due to radiogenic heating at the source (minerals rich in U or Th) and have a high content of dissolved radium and radon. Thus, in famous spas in Europe the ^{222}Rn concentration for "therapeutic inhalation" may be 1 MBq/m³ air (Baden-Baden). From the Joachimsthal U-mine in Bohemia, which contains a number of hot wells (29°C), water containing 10 - 15 MBq $^{222}\text{Rn}/\text{m}^3$ is pumped to spas, where it is used as medical treatment against rheumatism (a 30 min bath a day).

The average exhalation rate of radon from the ground is 5 - 50 mBq/m²s, leading to a near ground level radon concentration of 1 - 10 Bq/m³, but varies widely with ground conditions. In soil over Swedish uranium bearing shale (≈ 300 ppm U) the ^{222}Rn concentration can exceed 1 MBq/m³, though on the average the concentration in Scandinavian air (the main geology consists of granitic rocks) is only 3 Bq/m³. Representative values are for the US 0.1 - 10 Bq/m³, UK and Germany ~ 3 , and 10 (average) for France. The concentration in air above ground depends also on temperature and wind conditions.

Many ores contain small amounts of uranium. During processing, uranium and/or its daughters may enter the product, causing a radioactive contamination problem. For example, when apatite is used to produce phosphoric acid, the gypsum by-product contains all the radium originally present, producing a γ -ray and inhalation hazard from Rn-daughters, making it unsuitable for building material.

Radon concentrations in indoor air may be quite high, depending on site and building material. The ^{226}Ra content e.g. in German building materials varies from > 500 (gypsum) to 60 (brick) Bq/kg; slag used in Poland contains < 800 , Italian tuff ≈ 280 , concrete in Hungary ≈ 13 , and white bricks in the UK only ≈ 4 Bq/kg. The indoor concentration of radon also depends on the way in which the house is built and used (poorly ventilated, etc). In the US it varies between < 1 to > 1000 Bq/m³. Authorities no longer recommend very tight houses, as suggested in the 1970's to reduce heating costs. At levels < 70 Bq/m³ the Rn-hazard is considered negligible. In Sweden (pop. 8 M people) 50% of the houses have

70 - 200 Bq/m³, while 40 000 houses have been classified as "Rn-houses", i.e. their indoor concentration of Rn plus daughters exceed 400 Bq/m³. If the ground is the main source of radon, ventilation of the basement may be sufficient to declassify a "Rn-house".

Even coal contains small amounts of uranium, 4 to 300 kBq/ton, a typical value being 20 kBq/ton. When coal is burnt, the more volatile U-daughter products are released into the atmosphere, while the less volatile ones are deposited in the dust filters. A 1 GW_e coal-fired power plant typically releases 60 GBq ²²²Rn and 5 GBq ²¹⁰Pb + Po annually, while ~3 MBq daughter products are obtained per ton of fly ash.

5.7. Disequilibrium

Uranium ores at surface level are usually identified from the penetrating γ -ray emissions of the daughter products. However, it has been observed that some peat, which absorb uranium from local drainage, contain very little of the daughter products because they have been formed so recently that radioactive equilibrium has not been established.

The decay products of uranium passes over 10 elements (Fig. 5.1), all with very different chemical properties. These elements are transported by groundwater (*migrate*), the solute composition of which varies with the surrounding rock/soil minerals. The different elements migrate at different rates due to their different chemistries, dissolving in some areas and precipitating in others. If the mother and daughter in a radioactive chain migrate at different velocities during a time which is short in relation to the daughter half-life, the radioactive equilibrium is disturbed; this is referred to as *disequilibrium*. Such disequilibrium can be used to measure the age of the sample.

Let us consider the essential steps of the uranium decay series:

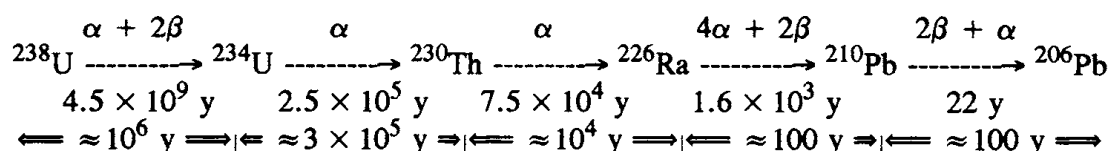

In this decay series the nuclide pairs which are suitable for determination of ages are associated with the time periods given between the double arrows of the two connected isotopes. For example, the ²³⁸U-decay to ²³⁴U passes over the short-lived intermediates ²³⁴Th ($t_{1/2}$ 24.1 d) and ²³⁴Pa ($t_{1/2}$ 1.17 m). The Th-isotope is long-lived enough to follow its own chemistry in a dynamic system. In strongly acidic solutions it forms Th⁴⁺ ions, while U forms UO₂²⁺ ions; the behavior of these two ions with regard to complex formation (e.g. by carbonates, hydroxyl or humic acid) and solubility is drastically different in neutral waters, leading to different migration rates for the two elements. For example, ²³⁸U may migrate away, while ²³⁴Th is precipitated or sorbed. As a result, when ²³⁴Th decays (via the rapid equilibrium with ²³⁴Pa) to ²³⁴U, the latter is free from ²³⁸U. From the deviation from the original activity ratio of ²³⁸U/²³⁴U = 1.0, (²³⁸U refers to the concentration of that isotope, see §2.3.2) the time since ²³⁸U and ²³⁴Th separated (i.e. the age of the sample) is deduced.

An example of such a system is the sedimentary uranium deposit in Tono, Japan, studied by Nohara et al. The ground water moves through the area with a velocity of 0.001 to 1

m/y. The specific activity ratios, measured by α - and $\beta\gamma$ -spectrometry, of $^{234}\text{U}/^{238}\text{U}$ is plotted against $^{230}\text{Th}/^{234}\text{U}$ (a), and $^{226}\text{Ra}/^{230}\text{Th}$ against $^{210}\text{Pb}/^{226}\text{Ra}$ (b) for a large number of rock samples in Figure 5.3. If radioactive equilibrium existed all ratios should be 1.0. The observation of deviations from 0.5 to 1.5 in (a) and up to 5 in (b) indicate that U, Th, Ra and Pb have migrated at different velocities in recent times. A detailed analysis yields the age of the U deposit and the migration rates of the daughter elements: the U and Th has not migrated during the past several hundred thousand years (this is probably also the age of the U deposit); Ra has migrated a few meters in the last 10 000 y.

5.8. Age determination from radioactive decay

Prior to the discovery of radioactivity, geologists could obtain only poor estimates of the time scale of the evolution of the earth. The oldest geologic materials were assumed to be some 10 million years old, and it was believed that this represented the age of the earth. However, with the discovery of radioactivity early in this century, geologists developed more objective methods for such age determination ("nuclear clocks"). In 1907 B. B. Boltwood obtained a value of 2.2×10^9 y for the age uranium and thorium minerals, assuming that all U and Th ultimately decayed to lead. Considering how few isotopes in the chains had been discovered at the time, the calculation was surprisingly good. Nuclear clocks have provided primary data on the age and evolution of the earth (*nuclear geochronology*) as well as the formation of elements and of the universe (*cosmochronology*).

The cosmogenic radionuclides with relatively short half-lives can be used to date materials of more recent origin; e.g., ^3H for water movements in the geosphere, and ^{14}C for organic material of archaeological interest. Practically all of the primordial radionuclides (Table 5.2) can be used for dating geologic materials: $^{40}\text{K}/^{40}\text{Ar}$ for igneous (plutonic) rocks (i.e. rocks which have solidified from a rather homogenous melt); $^{87}\text{Rb}/^{87}\text{Sr}$ for metamorphic and sedimentary rocks; $^{147}\text{Sm}/^{143}\text{Nd}$ for rock-forming silicate, phosphate and carbonate minerals; $^{187}\text{Re}/^{187}\text{Os}$ for sulfides and metallic material like iron meteorites, etc.

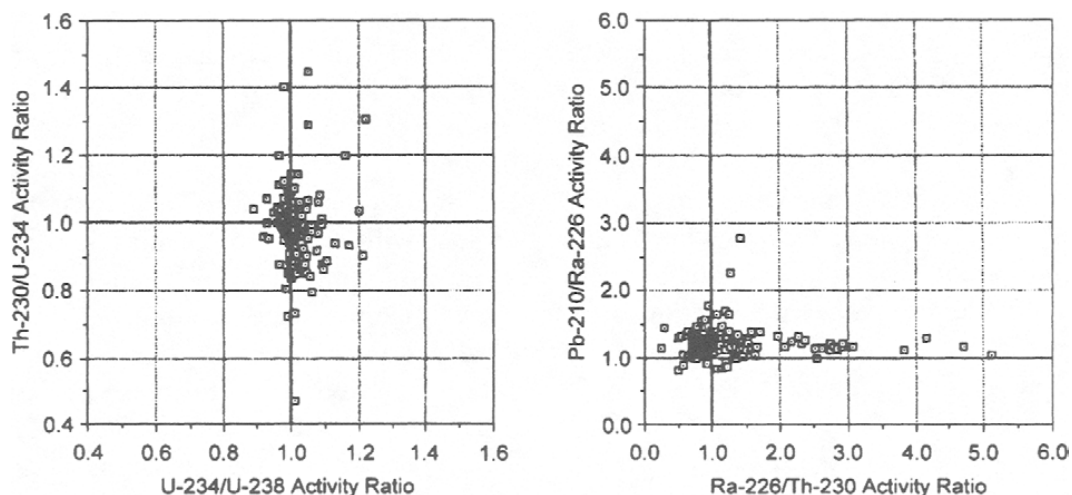

FIG. 5.3. Activity ratios $^{234}\text{U}/^{238}\text{U}$ vs $^{230}\text{Th}/^{234}\text{U}$, and $^{226}\text{Ra}/^{230}\text{Th}$ vs $^{210}\text{Pb}/^{226}\text{Ra}$ for rock samples from the Tono uranium deposit. (From Nohara et al.)

5.8.1. Dating by the ^{14}C method

It is reasonable to assume that the production of ^{14}C in the atmosphere has been constant for at least a million years, which means that equilibrium exists between the rates of formation and decay of the ^{14}C in the atmosphere. Moreover, the half-life of ^{14}C is sufficient to allow equilibrium between the ^{14}C in the atmosphere, the oceans (including precipitations to ocean bottoms), and exchangeable carbon in natural materials. Thus from measurement of the specific radioactivity of carbon, it should be possible to determine when the sample became isolated from its natural environmental compartment.

The discovery that all living organic material has a certain specific radioactivity due to ^{14}C led W. Libby to a new method for determination of the age of biological material. This method, which has been of great importance in dating archeological, geological, etc materials, is based on the assumption (i) that cosmogenic ^{14}C has been produced at a constant rate, (ii) that the amount of anthropogenic ^{14}C is negligible compared to the cosmogenic, (iii) that after the organism incorporating the biological material died, no exchange occurs between the carbon atoms of the material and those of the surroundings. In such material the number of ^{14}C atoms decreases with time according to the half-life of ^{14}C . The equation is (for notation, see § 4.13)

$$^{14}\text{C} \text{ (Bq/g)} = ^{14}\text{C}_0 e^{-0.693t/5568} \quad (5.3a)$$

or

$$t \text{ (y)} = (\log ^{14}\text{C}_0 - \log ^{14}\text{C}) 5568/0.301 \quad (5.3b)$$

where $^{14}\text{C}_0$ is the initial ^{14}C activity of a standard ($^{14}\text{C}_0 \approx 14$ dpm/g, c.f. § 5.1.3) at time of death of the plant, etc ($t = 0$). The reference time for ^{14}C ages is AD 1950, which is indicated with the letters bp or BP (for "before present"). The half-life of 5568 y is a standard reference value introduced by Libby. For example, if the specific activity of a sample is measured to be 0.1 dpm/g, then (5.3b) gives a value of 39 700 years as the time since the material ceased to exchange its carbon. Only with extreme care and very sophisticated equipment can a specimen this old be determined with reliability, but shorter times can be measured more accurately since the specific activities are larger. ^{14}C ages are used for dating specimen of 300 to 50 000 y, with an uncertainty of 10 - 100 y. ^{14}C -determinations were originally made by transferring the carbon into carbon dioxide, which was measured in an internal GM-counter (Ch. 8). Later, transformation into methane was preferred, and the CH_4 counted in an internal proportional counter. The most sensitive technique today is to introduce the sample into the ion source of a tandem-van-der-Graaff accelerator and "count" the amount of ^{14}C -ions relative to ^{12}C -ions by mass-spectrometry.

There are many cautions that must be observed in the use of carbon dating. In addition to those mentioned above, there is the possibility of isotopic effects in metabolic processes. These could cause ^{14}C to be slightly depleted relative to ^{12}C due to chemical reactions in the biological material. To take this into account to get the correct "solar age" instead of a slightly misleading " ^{14}C age", the isotopic depletion can be determined from deviations in the $^{12}\text{C}/^{13}\text{C}$ ratio. A " $\delta^{13}\text{C}$ correction" is introduced according to

$$^{14}\text{C}_{\text{corr}} = ^{14}\text{C} \left\{ 1 - 2(\delta^{13}\text{C} + 25)/1000 \right\} \quad (5.4)$$

The value of $\delta^{13}\text{C}$ differs for various substances; e.g. -35 to -20 for terrestrial organic matter, -8 to -7 for atmospheric CO_2 , etc. Figure 5.4 illustrates the use of various $\delta^{13}\text{C}$ values for biological matter. These corrections lead to considerable adjustments of conventional ^{14}C ages; e.g. for the period 7 000 to 2 000 years ago, corrections increase ages by up to 1 000 y.

Another necessary correction has to be made for changes in the cosmic ray irradiation, which, *a priori* was assumed to be constant, but is not over long geological periods. By counting the number of annular rings on old trees such as the *Sequoia gigantea*, which can be almost 4 000 years old, and determining the ^{14}C content of each ring, the variation of cosmic radiation through thousands of years can be studied accurately, see Figure 5.5. Obviously there is a periodic cycle of some 10 000 y, which coincides with the variation in warm periods and small ice ages.

A large number of important age determinations have been made with the ^{14}C dating method. It was believed that a large ice cap had covered parts of the North American continent until about 35 000 years ago. Dating of wood and peat by the ^{14}C method has shown that the ice must have lasted until about 11 000 years ago. Moreover, several hundred pairs of sandals found in a cave in Oregon have been shown to be about 9 000 years old, indicating that tribes with significant cultures had developed soon after the withdrawal of the ice cap from North America. By analyzing inorganic carbon in bone apatite, it has been determined that hunters in Arizona killed mammoths there 11 300 years ago. Another example of the use of ^{14}C dating which has attracted widespread attention involves the Dead Sea scrolls. There was considerable controversy about their authenticity until ^{14}C dating showed their age to be slightly more than 1 900 years.

Some researchers claim that ^{14}C -ages lag behind with as much as 3 500 years for times close to 20 000 y, when compared to U-Th dating (§5.8.4). Such adjustments play a large role in the debate about cultural migrations. It is interesting to note that adjusted ^{14}C -dates now have led to the conclusion that e.g. the stone monuments in Carnac, Brittany, are believed to be $> 6 000$ years old, i.e. older than the cultures in Egypt and Babylon. Similarly, grave mounds near the ancient edge of the inland ice in southern Norway and in Newfoundland have been found to be $> 7 000$ years old.

5.8.2. Dating by K-Ar method

Potassium is the eighth most abundant element in the earth's crust and occurs in many important rock-forming minerals. The radioactive isotope ^{40}K is present only to 0.0117% in natural potassium. It has a branched decay as follows:

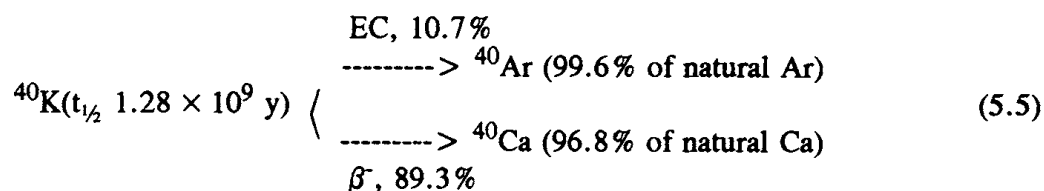

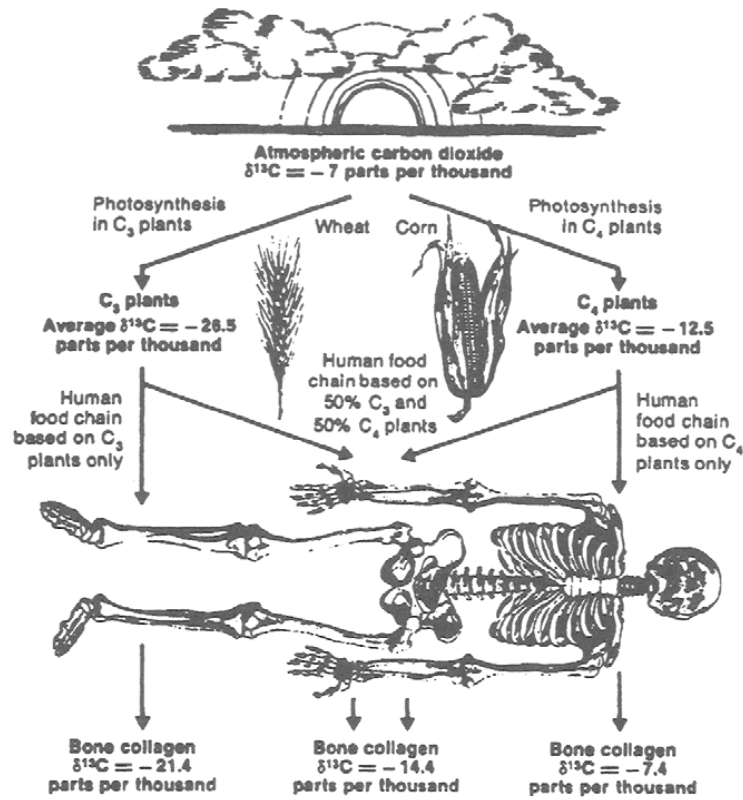

FIG. 5.4. Ratio of $^{13}\text{C}/^{12}\text{C}$ in human bone depends on diet and affects the $\delta^{13}\text{C}$ correction factor. (From American Scientist, 70 (1982) 602.)

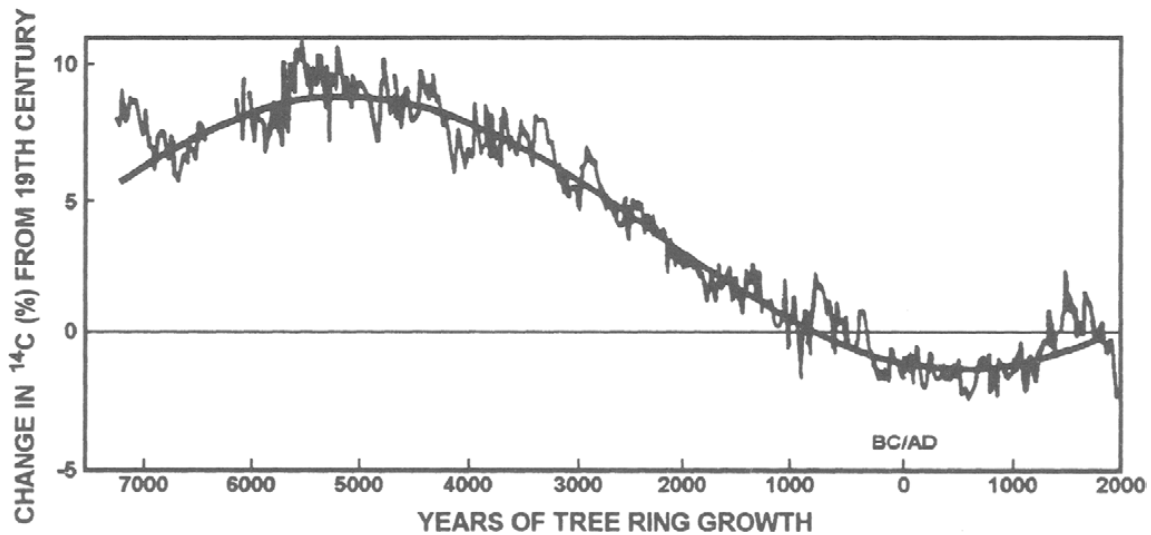

FIG. 5.5. Long term variation in atmospheric ^{14}C activity as determined from tree rings. (From H. E. Suess, La Jolla Radiocarbon Lab.)

$\lambda_{\text{EC}} = 0.578 \times 10^{10} \text{ y}^{-1}$, $\lambda_{\beta} = 4.837 \times 10^{-10} \text{ y}^{-1}$, $E_{\text{max}} = 1.32 \text{ MeV}$. Because the ^{40}K half-life is of the same magnitude as the age of the earth, measurement of the $^{40}\text{K}/^{40}\text{Ar}$ ratio can be used to determine ages of the oldest K-containing minerals (for notation, see §2.3.2). From the decay scheme one can derive the equation

$$t = \lambda^{-1} \ln[\{^{40}\text{Ar}/(0.107 ^{40}\text{K})\} + 1] \quad (5.6)$$

where λ is the total decay constant ($= \lambda_{\text{EC}} + \lambda_{\beta}$; see §4.12), ^{40}Ar represents the concentration of ^{40}Ar -atoms in the sample (i.e. number of radiogenic atoms of ^{40}Ar per unit sample weight), and ^{40}K is the present atomic abundance of ^{40}K -atoms. This equation assumes that all ^{40}Ar in the mineral is radiogenic. Any amount of non-radiogenic ^{40}Ar present initially (e.g. dissolved in the magma from which the mineral formed) is denoted as $^{40}\text{Ar}_i$. Thus the present amount of ^{40}Ar is the sum of the radiogenic amount and that originally present:

$$^{40}\text{Ar} = ^{40}\text{Ar}_i + \lambda_{\text{EC}} \lambda^{-1} ^{40}\text{K} (e^{\lambda t} - 1) \quad (5.7)$$

The problem is that both t and $^{40}\text{Ar}_i$ are unknown. This can be solved by dividing equation (5.7) by the number of ^{36}Ar atoms in the sample, yielding

$$^{40}\text{Ar}/^{36}\text{Ar} = (^{40}\text{Ar}/^{36}\text{Ar})_i + (\lambda_{\text{EC}} / \lambda)(^{40}\text{K}/^{36}\text{Ar})\{e^{\lambda t} - 1\} \quad (5.8)$$

Because ^{36}Ar is a stable non-radiogenic isotope, its amount in the sample should not change by time. Thus the measured $^{40}\text{Ar}/^{36}\text{Ar}$ ratio is the sum of the original and the radiogenic contributions from ^{40}Ar . Mineral samples of the same origin (so-called *cogenetic*) should have the same initial $^{40}\text{Ar}/^{36}\text{Ar}$ ratio and be of the same age (same t), though the $^{40}\text{K}/^{36}\text{Ar}$ may vary. Thus for cogenetic samples a plot of $^{40}\text{Ar}/^{36}\text{Ar}$ versus $^{40}\text{K}/^{36}\text{Ar}$ should yield a straight line, from the slope of which t is calculated. This line is referred to as an *isochron*. From the isochron for the rock sample from Tanzania in Figure 5.6, its age is calculated to be $(2.04 \pm 0.02) \times 10^6 \text{ y}$, which is an interesting result as remains of early humans has been found in the same tuff matrix.

5.8.3. Dating by Rb–Sr method

Some uncertainty is associated with the use of the $^{40}\text{K}/^{40}\text{Ar}$ ratio because of the possibility of the loss of gaseous argon from minerals. An alternative method is based on $^{87}\text{Rb}/^{87}\text{Sr}$ system:

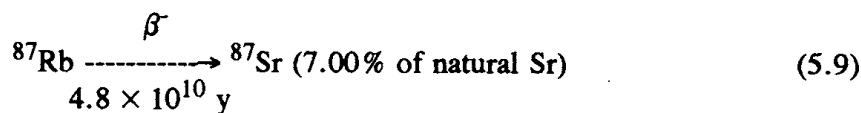

The measurement of the $^{87}\text{Rb}/^{87}\text{Sr}$ ratio by isotope dilution and mass spectrometry is one of the most reliable methods for geologic age determinations. Meteorite values as high as $4.7 \times 10^9 \text{ y}$ have been obtained, indicating that this is the age of the solar system. For the

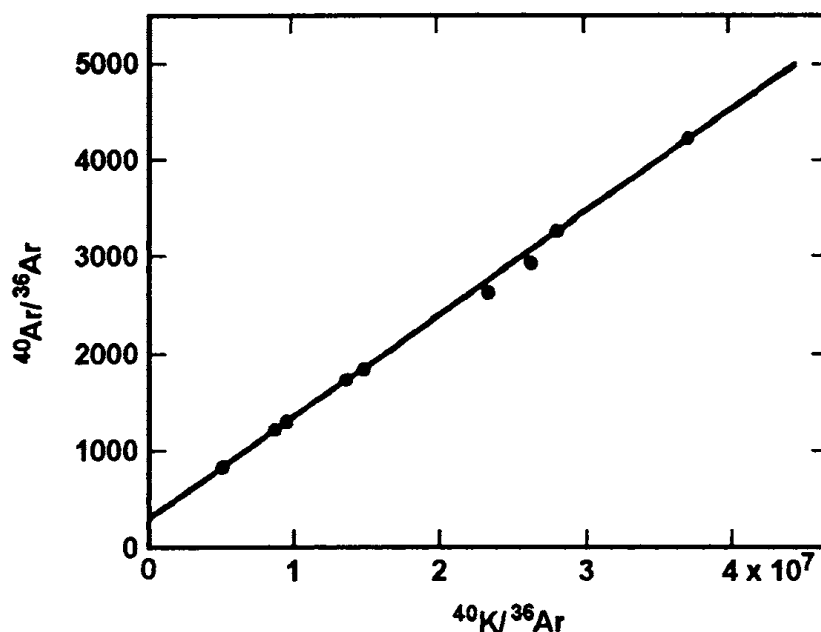

FIG. 5.6. K–Ar isochron of tuff from Olduvai Gorge, Tanzania, yielding a slope corresponding to an age of 2.04 ± 0.02 My. (From Faure.)

Rb-Sr clock a relation of type (5.9) is valid although corrections must be made for any non-radiogenic ^{87}Sr present; it is believed that the primordial $^{87}\text{Sr}/^{86}\text{Sr}$ ratio was 0.70.

5.8.4. Dating based on ^{238}U decay

In the uranium decay series 8 α -particles are emitted in the decay from ^{238}U to ^{206}Pb . Thus for every 8 helium atoms found in a uranium mineral, one atom of ^{238}U must have decayed to ^{206}Pb . Designating the number of original uranium atoms in the sample at time 0 as $^{238}\text{U}_0$, the number which has decayed with time t would be $^{238}\text{U}_0 - ^{238}\text{U}$, where the last number refers to the uranium atoms present now. Then $^{238}\text{U}_0 - ^{238}\text{U} = \text{He}/8$, where He is the number of helium atoms made. From this it is relatively easy to derive an equation from which t , i.e. the age of the mineral, can be calculated once the values of ^{238}U and He are known. For accurate calculations, it is necessary to correct for the formation of helium from the decay of the ^{235}U and ^{232}Th also present in the mineral (see Fig. 5.1). Further, if the mineral has lost any helium through diffusion or other processes during its existence, the helium content would be abnormally low, leading to erroneously small values of t . This method, therefore, can only give lower limits of the ages of minerals.

Another common method of dating U-minerals is by considering its content of lead isotopes. Lead has four stable isotopes of which three are end products of radioactive decay series. The fourth lead isotope, ^{204}Pb , is found in lead minerals in about 1.4% isotopic abundance and has no radio-genetic origin. At the time of formation of the earth, all the ^{204}Pb in nature must have been mixed with unknown amounts of the other lead isotopes. If a lead-containing mineral lacks ^{204}Pb , it can be assumed that presence of the other lead isotopes together with uranium and/or thorium must be due to their formation in the decay

series. In such ^{204}Pb -free minerals if it is possible to determine the amount of the parent nuclide ^{238}U and of the end product ^{206}Pb , the age of the mineral can be obtained from the general equation

$$t = \lambda^{-1} \ln(1 + N_d/N_p) \quad (5.10)$$

where N_p is the number of parent atoms (e.g. ^{238}U) and N_d the number of radiogenic daughter atoms (e.g. ^{206}Pb), and λ is the decay constant of the parent. The atomic ratios between a number of isotopic pairs as a function of time is shown in Figure 5.7.

This method is more reliable than the helium method since there is very little possibility of any of the lead that has been formed by radioactive decay having diffused or been leached from the mineral during its geologic age. Mineral samples from the earth have yielded values as great as 3×10^9 y by the lead content method. Unfortunately, there is a problem with this method also. The decay series all pass through isotopes of the inert gas radon, and if some of the radon is lost from the mineral the ^{206}Pb content leads to an erroneously low age. However, if relation (5.13) is used for different decay series (i.e. the ^{238}U and the ^{235}U series) and the same t is obtained, the data are said to be *concordant*. Such data increases the confidence in the measured age.

Since the lifetimes of the uranium isotopes ^{238}U and ^{235}U are different, the isotopic ratio between their end products ^{206}Pb and ^{207}Pb can also be used for age determination. One can derive the relationship

$$^{207}\text{Pb}/^{206}\text{Pb} = (1/138)(e^{\lambda_{235} t} - 1)/(e^{\lambda_{238} t} - 1) \quad (5.11)$$

where the factor 1/138 is the present isotopic abundance ratio of the uranium isotopes. This method has given values of 2.6×10^9 y for uranium and thorium minerals. When applied to stony meteorites, a somewhat longer age of $(4.55 \pm 0.07) \times 10^9$ y is obtained.

When lead is extracted from the ore it is in secular equilibrium with its precursors radium and uranium. The radium and most of its descendants are removed during processing while the ^{210}Pb accompanies the other lead isotopes. The separation of radium from lead is not always complete. Because of the long half-life of ^{226}Ra (1600 y) as compared to the short-lived ^{210}Pb (22.3 y), the determination of the excess ^{210}Pb over the equilibrium amount received from ^{226}Ra decay provides a scale for the time since the manufacture of the lead. This was used to verify forgeries of paintings claimed to be made by the Dutch artist Vermeer van Delft (1632 - 1675). The paintings were in fact made by H van Meegeren (1889 - 1948), in the 1940's and were so excellent in style that every authority accepted them as authentic. When threatened by the death penalty for selling such national treasures to the Germans during World War II, van Meegeren confessed the forgery, and his story was verified by dating the lead in the "lead white", PbSO_4 , in the fake "Vermeers".

5.9. Natural radioactivity of the oceans

The total amounts of ^{238}U and ^{232}Th in the ocean are 4.3×10^{12} kg (53 EBq) and 6.9×10^{10} kg (0.3 EBq), respectively. The oceans contain a much higher concentration of uranium than would be expected from its abundance in rocks. It also occurs at much larger

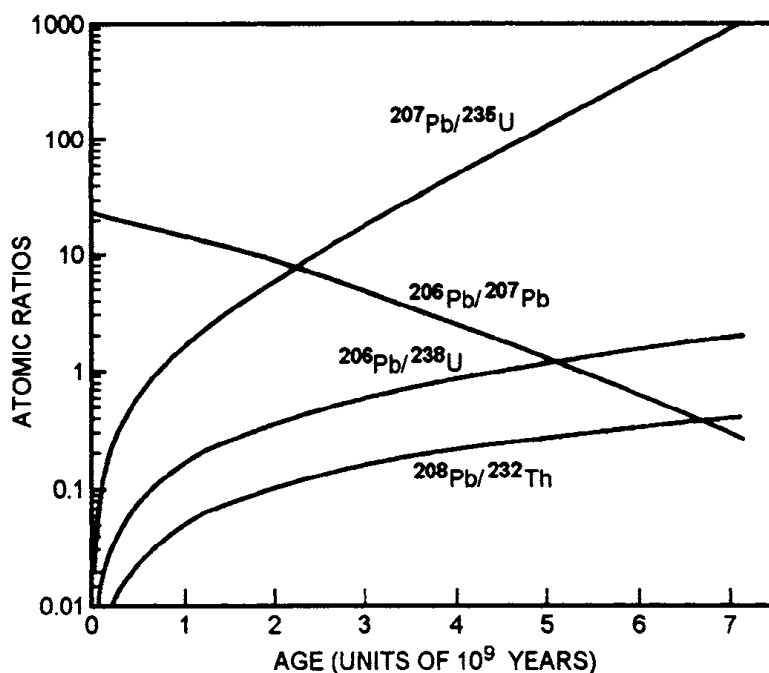

FIG. 5.7. Atomic ratios at the time of measurement as a function of the age of the minerals. (From E. K. Hyde.)

concentration than thorium, even though the latter element is more abundant in rocks. This is explained by the absence of easily soluble thorium complexes, in contrast to the strong $\text{UO}_2(\text{CO}_3)_3^{4-}$ complex. ^{238}U decays to ^{234}Th ($t_{1/2}$ 24.1 d), which precipitates out or absorbs to colloids before it decays to ^{234}U , causing a slight disequilibrium between the two U-isotopes. This is used to determine the mean residence time of Th in the oceans: ~ 200 y; by contrast, the residence time of U in the ocean is 5×10^5 y. The decay passes the long-lived ^{230}Th ($t_{1/2}$ 75 400 y), which deposits in sediments before radioactive equilibrium is reached with ^{226}Ra ($t_{1/2}$ 1600 y); consequently the specific activity of ^{226}Ra is less than expected from the U-content (39 Bq/m^3), only 1 - 10 Bq/m^3 . It should be noted that the ^{222}Rn concentration in surface waters is in disequilibrium with ^{226}Ra because Rn is vented by heat, turbulence, etc.

As the total content of ^{40}K in the oceans is 74×10^{12} kg, corresponding to 19.4×10^3 EBq, ^{40}K is the largest source of radioactivity in the oceans. Minor activities come from ^3H as HTO and from ^{14}C as dissolved CO_2 or HCO_3^- .

5.10. Anthropogenic radioactivity in nature

In the analysis of a sample for its content of natural radioactivity it is necessary today to consider the possibility that the sample has become contaminated by "non-natural" radioactivities, i.e. radionuclides added to by human activities (so-called *anthropogenic sources*). Nuclear weapons tests, nuclear satellites burnt-up in the atmosphere, and nuclear power accidents may release large amounts of activities, see Table 5.4. The nuclear power industry is permitted by health authorities to continually release small, controlled amounts of specified radionuclides into the atmosphere and into open waters, Tables 19.7 and 21.10.

Effluents may also come from large radiotracer users (especially hospitals). In most cases these releases are well known and the area concerned ("contaminated") identified. From a global standpoint, compared to natural radioactivity, these releases are minor, but they do add to the our "natural" radiation background, as discussed in Chapters 18 and 22.

Usually one distinguishes between "near field" and "far field" effects of radioactivity releases. Near field effects are observed close to the release source, as for example the nuclear power plant or nuclear waste storage facility. The dissolution of nuclear waste by rain or ground water is a typical near field problem. As the source is known, it can be controlled and its environment monitored. If the radioactivity exceeds permitted levels, access to the contaminated area can be restricted. Far field effects involve the behavior of radionuclides which have spread out of such a restricted area, caused either by nuclear power accidents and weapons tests or by leakage from nuclear power plants.

In this paragraph we briefly describe some of the largest anthropogenic sources causing far field effects, i.e. nuclear weapons tests and nuclear power plant accidents. The cause of the releases is discussed in Chapter 19. Chapter 22 discusses both near and far field effects in further detail, particularly with regard to chemical properties: liquid releases from nuclear power plants, dissolution of solidified nuclear waste and of fall-out particles, migration in the environment, and possible consequences.

5.10.1. Nuclear weapons

Nuclear weapons were tested in the atmosphere up to 1990, with total releases up to 2×10^{20} Bq fission products, as well as some lesser amounts of Pu isotopes; cf. Table 22.2. Most of the debris injected into the troposphere had a mean residence time of ~ 30 d, causing fall-out mostly in the neighborhood of the test area. Some of the debris passed through the tropopause and entered the stratosphere where it was carried by winds around the globe at approximately the latitude of the release. The residence time in the stratosphere

TABLE 5.4. Events leading to large injections of radionuclides into the atmosphere

Source	Country	Time	Radioactivity Bq	Important nuclides
Hiroshima & Nagasaki	Japan	1945	4×10^{16}	Fiss.prod. Actinides
Atmospheric weapons tests	USA USSR	– 1963	2×10^{20}	Fiss. prod. Actinides
Windscale	UK	1957	1×10^{15}	^{131}I
Chelyabinsk (Kysthym)	USSR	1957	8×10^{16}	Fiss. prod. ^{90}Sr , ^{137}Cs
Harrisburg	USA	1979	1×10^{12}	Noble gases, ^{131}I
Chernobyl	USSR	1986	2×10^{18}	^{137}Cs

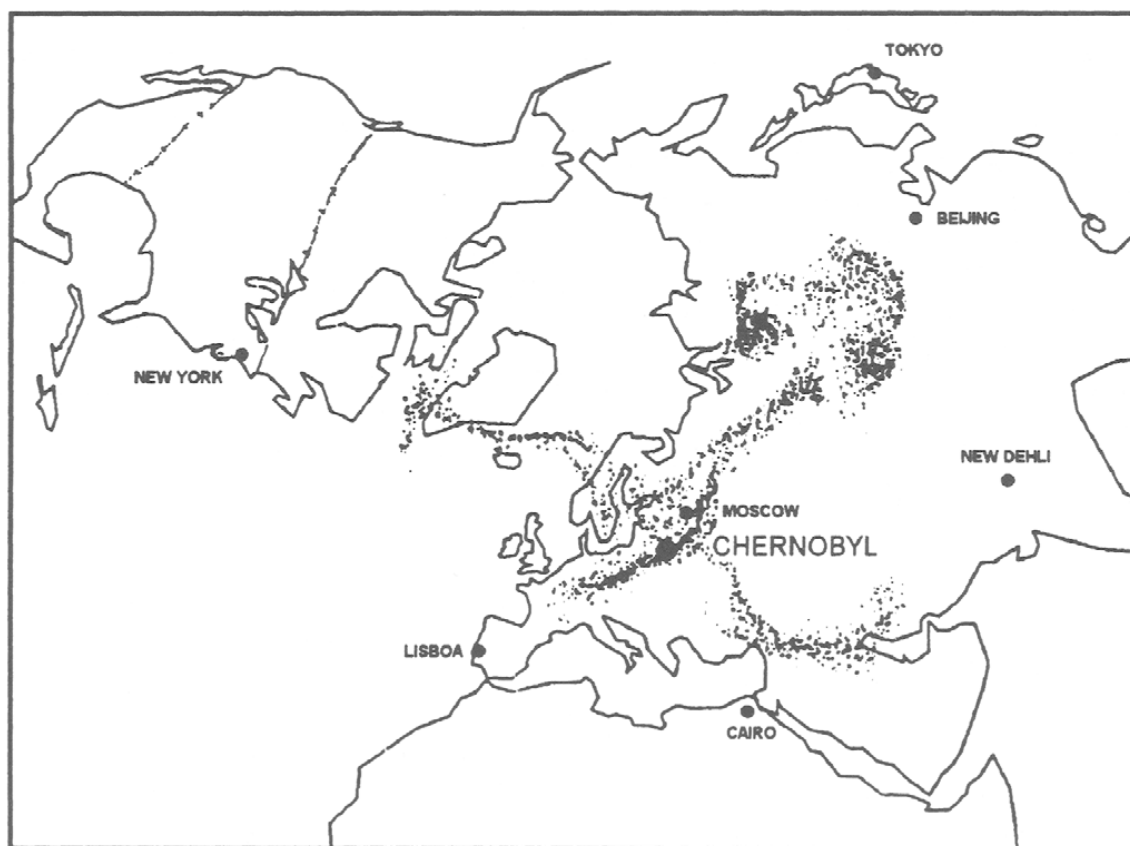

FIG. 5.8. The distribution of the airborne radioactivity from Chernobyl.

is 3 – 24 months depending on latitude (greatest at the equator). The average surface deposition is 2500 Bq/m^2 at $40 - 50^\circ\text{N}$, decreasing towards north and south (< 800 at $> 70^\circ\text{N}$ and at $< 20^\circ\text{N}$). The global integrated deposition density for ^{241}Pu is $\sim 440 \text{ Bq/m}^2$ and the air concentration is $\sim 0.8 \text{ mBq/m}^3$.

Because the atmospheric tests stopped in 1990, the fission products have decayed for $> 10 \text{ y}$, leaving almost only ^{90}Sr , ^{137}Cs and Pu "active". Comparing with global natural radioactivity the contributions of these isotopes to our environment is negligible today, except for T and ^{14}C .

5.10.2. Nuclear power plant accidents

In 1957 a fire developed in one of the gas cooled graphite moderated reactors at *Windscale*, UK. The main radionuclides released were (in TBq) ^{131}I 700, ^{137}Cs 20, ^{89}Sr 3 and ^{90}Sr 0.3. The largest air concentration close to the plant was 20 kBq/m^3 . The Cs activity deposited was $\leq 4 \text{ kBq/m}^2$. The ground activity is now back to normal.

In 1979 a partial core melt-down occurred in a reactor at Three Mile Island power station (TMI), *Harrisburg*, Pennsylvania. Although the fission products released from the core were almost completely contained within the building, the Xe and Kr and some iodine ($\sim 1 \text{ TBq } ^{131}\text{I}$) were released. No deposition occurred on ground outside the building.

The explosion and fire in one of the power reactors at *Chernobyl*, Soviet Union, in 1986, was a more severe accident (§§20.1.2 and 22.3). For several days large amounts of fission products and actinides were ejected and spread over large areas of the former USSR and Europe, see Figure 5.8. Almost 20% of the fission products came down over Scandinavia, causing a deposition $> 120 \text{ kBq } ^{137}\text{Cs}/\text{m}^2$ over the city Gävle in Sweden (170 km north of Stockholm). The plume spread down over Central Europe, causing very uneven deposition due to wind pattern and local rains: e.g., Munich, Germany, received $\leq 25 \text{ kBq } ^{137}\text{Cs}$ and $0.2 \text{ kBq } ^{90}\text{Sr}$ per m^2 , while Mainz (400 km away) received $180 \text{ Bq } ^{137}\text{Cs}$ and $\sim 0.001 \text{ Bq } ^{90}\text{Sr}$ per m^2 , see also §22.3.

In 1957 an explosion occurred in a nuclear waste storage facility (probably due to reactions between organic matter and nitrate) at Kyshtym south of Sverdlovsk, USSR, leading to the contamination of approximately 1600 km^2 of land by $8 \times 10^{16} \text{ Bq}$ fission products, causing local contaminations exceeding $10^{10} \text{ Bq}/\text{m}^2$ ($2 \times 10^8 \text{ } ^{90}\text{Sr}$ and ^{137}Cs). The area is still uninhabitable, see also §21.10.

5.10.3. Releases from nuclear power plants

All nuclear power plants are carefully controlled by the national radiation protection boards, and strict limits for releases are set. Usually it is quite easy for the power plants to meet these requirements. These releases are small compared to the natural radioactivities and mostly negligible in the far field, see §§20.4 and 21.8.

5.10.4. Other anthropogenic additions

In 1975 the *London Dumping Convention* set limits to dumping of nuclear waste in the Oceans to places far of shipping trades and fishing areas and at depths $> 4000 \text{ m}$. Earlier dumping had been common practice by the nuclear powers even in narrow (the British Channel) and shallow (up to 50 m) waters to get rid of large volumes of low level long-lived waste. Officially reported dumpings were made as early as in 1946 and continued in the Pacific and the North Atlantic until 1982 and in the Barents and Kara seas even later. East of the British Islands the U.K. has dumped 665 TBq, France 134 TBq and other countries together some 35 GBq. In total some 45 PBq have been dumped at 46 different sites, mostly at depths of 1400 - 6500 m. Measurements reveal that in some cases radioactive nuclides are leaking out from the containers, causing bottom contamination at the site; however, the radionuclides are rapidly diluted as they are carried away by bottom currents.

Recently it was disclosed that the former USSR made huge dumps of nuclear waste in the waters east of Novaya Semlya: some 10 000 containers and 13 nuclear reactors (8 still containing fuel), mainly from nuclear submarines. In some places the waste is at very shallow waters (some 30 m). The total activity is estimated to $> 60 \text{ PBq}$. The waste will ultimately leak out and spread with westerly currents towards the Barents Sea and the North Atlantic. However, the releases are expected to be rapidly diluted to harmless concentrations.

5.11. Exercises

5.1. Cosmic-ray irradiation of the atmosphere yields $0.036 \text{ }^{10}\text{Be atoms cm}^{-2} \text{ s}^{-1}$. If this ^{10}Be is rapidly carried down into sea water, which is assumed to have a volume of $1.4 \times 10^{18} \text{ m}^3$, what will the equilibrium radioactivity of ^{10}Be in 1 m^3 sea water be? The earth's surface area is $510 \times 10^6 \text{ km}^2$.

5.2. In Greenland ice the ^{10}Be radioactivity has been measured to be $0.0184 \text{ dpm m}^{-3}$. How old is this ice if it was formed out of water in equilibrium with cosmic-ray ^{10}Be (see previous question)?

5.3. The CO_2 in the atmosphere is in exchange with carbon in living organisms, humus, dissolved organic compounds, and carbonate in the sea water, the latter being the main reservoir (88%) of all exchangeable carbon. The amount of such exchangeable carbon is estimated to be 7.9 g cm^{-2} of the earth. When cosmic-ray produced ^{14}C is mixed into this exchangeable carbon, what will the specific activity become?

5.4. On the label of a bottle of cognac bought in 1976 it is stated that the cognac is over 20 years old. An analysis showed a tritium content of 80 TU. Discuss the trustworthiness of the statement.

5.5. 0.11 cm^3 helium gas at NTP was isolated from 100 g of uranium mineral containing 5 ppm uranium. How old is the mineral?

5.6. A mineral was found to contain 39.1 g K and 87.2×10^{-6} liter Ar at NTP. How old is the mineral?

5.7. A uranium mineral was found to contain the lead isotopes ^{204}Pb , ^{206}Pb , and ^{207}Pb in the ratio 1:1087:388, as determined with a mass spectrometer. Estimate the age of the mineral.

5.8. The heat flow from the earth's crust is 0.060 W m^{-2} . The mean thickness of the crust is 17 km and the earth's radius is 6371 km. The average concentration of uranium, thorium, and potassium in granite is estimated to be 4 ppm (by weight) 18 ppm, and 3.6%, respectively. Assuming that 7% by volume of the crust is made up of granite (feldspar + quartz, density 2.6 g cm^{-3}), what will the heat flow at the earth's surface be from each of these elements? Assume β -heat as $1/3 E_{\text{max}}$; for α -decay assume $E_{\alpha} = Q_{\alpha}$. Each ^{40}K decay by the EC-branch emits one 1.46 MeV γ . Discuss the results.

5.9. A 1 GW_e nuclear power station uses annually about 30 t uranium enriched to 3% ^{235}U . (a) How much natural uranium has been produced to keep it running? Assume waste stream from isotope separation plant to contain 0.3% ^{235}U . (b) How much low grade ore (assume 0.06% uranium) must be mined, if the uranium recovery efficiency in the process is 70%?

5.10. The assumed uranium resources in Japan are 4 kt, in Argentina 12 kt and in France 48 kt U_3O_8 . How many 1 GW_e reactor years can these uranium amounts sustain in each country at the uranium consumption rate (a) of the previous exercise?

5.12. Literature

E. K. HYDE, *Natural Radioactivity of the Heavy Elements: A Comprehensive Review*, Univ. of California Radiation Laboratory, Report UCRL-10612.

W. F. LIBBY, *Radiocarbon Dating*, University of Chicago Press, 1956.

C. E. JUNGE, *Air Chemistry and Radioactivity*, Academic Press, 1963.

H. CRAIG, S. L. MILLER, and G. J. WASSERBURG (Eds.), *Isotopic and Cosmic Chemistry*, North-Holland, 1963.

E. I. HAMILTON and L. H. AHRENS, *Applied Geochronology*, Academic Press, 1965.

B. KEISCH, Dating works of art through their natural radioactivity: improvements and applications, *Science* **160** (1968) 413.

D. YORK and R. M. FARQUHAR, *The Earth's Age and Geochronology*, Pergamon Press, 1972.

P. K. KURODA, Fossil nuclear reactor and plutonium-244 in the early history of the solar system. In IAEA, *The Oklo-phenomenon*, Vienna, 1976.

Ionizing Radiation: *Sources and Biological Effects*, United Nations 1982.

P. S. ZURER, Archeological Chemistry, *Chem. & Eng. News Febr.* **21**, 1983, p.21.

P. J. D. LLOYD, p. 772 in T. LO, M. BAIRD and C. HANSON, (Eds.), *Handbook of Solvent Extraction*, J. Wiley & Sons 1983.

G. FAURE, *Principles of Isotope Geology*, 2nd Ed. J Wiley & Sons 1986.

M. EISENBUD, *Environmental Radioactivity*, 3rd Ed., Academic Press 1987.

M. A. GEYH and H. SCHLEICHER, *Absolute Age Determination*, Springer-Verlag 1990.

G. BRIMHALL, The Genesis of Ores, *Sci. Am.*, May 1991, p.48

Fuel Review 1991, Nucl. Eng. Int. Spec. Publ. 1991.

L. MOBERG (Ed.), *The Chernobyl Fallout in Sweden*, The Swedish Radiation Protection Institute, Box 60024, S-10401 Stockholm 1991.

T. NOHARA, Y. OCHIAI, T. SEO AND H. YOSHIDA, PNC, Gifu, Japan, Private communication.

C. MUSIKAS and W. SCHULZ, p. 418 in J. RYDBERG, C. MUSIKAS and G. CHOPPIN (Eds.), *Principles and Practices of Solvent Extraction*, Marcel Dekker 1992.

Nuclear Geophysics (Int. J. Radiation Appl. and Instrumentation Part E), published by Pergamon Press

World Nuclear Industry Handbook, Nucl. Eng. Int. Spec. Publ. 2000.